

По вопросам продаж и поддержки обращайтесь:

Архангельск (8182)63-90-72	Краснодар (861)203-40-90	Рязань (4912)46-61-64
Астана (7172)727-132	Красноярск (391)204-63-61	Самара (846)206-03-16
Белгород (4722)40-23-64	Курск (4712)77-13-04	Санкт-Петербург (812)309-46-40
Брянск (4832)59-03-52	Липецк (4742)52-20-81	Саратов (845)249-38-78
Владивосток (423)249-28-31	Магнитогорск (3519)55-03-13	Смоленск (4812)29-41-54
Волгоград (844)278-03-48	Москва (495)268-04-70	Сочи (862)225-72-31
Вологда (8172)26-41-59	Мурманск (8152)59-64-93	Ставрополь (8652)20-65-13
Воронеж (473)204-51-73	Набережные Челны (8552)20-53-41	Тверь (4822)63-31-35
Екатеринбург (343)384-55-89	Нижний Новгород (831)429-08-12	Томск (3822)98-41-53
Иваново (4932)77-34-06	Новокузнецк (3843)20-46-81	Тула (4872)74-02-29
Ижевск (3412)26-03-58	Новосибирск (383)227-86-73	Тюмень (3452)66-21-18
Казань (843)206-01-48	Орел (4862)44-53-42	Ульяновск (8422)24-23-59
Калининград (4012)72-03-81	Оренбург (3532)37-68-04	Уфа (347)229-48-12
Калуга (4842)92-23-67	Пенза (8412)22-31-16	Челябинск (351)202-03-61
Кемерово (3842)65-04-62	Пермь (342)205-81-47	Череповец (8202)49-02-64
Киров (8332)68-02-04	Ростов-на-Дону (863)308-18-15	Ярославль (4852)69-52-93

Единый адрес: btk@nt-rt.ru **Веб-сайт:** www.burkert.nt-rt.ru

ДАТЧИКИ И РЕЛЕ ДАВЛЕНИЯ



Bourdon tube pressure gauge, back or lower mount connection

- For gases and not crystallizing liquids
- Back or radial mount lower connection
- Different sizes and measurement ranges

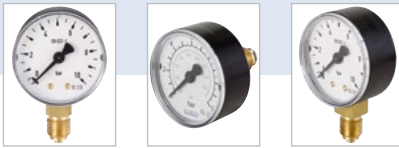

Product variants described in the data sheet may differ from the product presentation and description.

Type description

Manometer for the pressure measurement of neutral and aggressive gases and not crystallizing liquids with small viscosity, that will not attack copper alloy manometer interior parts. A circular bourdon tube in alloyed copper is used as sensor.

1. General technical data

Product properties	
Dimensions	See "2. Dimensions" on page 4
Materials	
Case material	Plastic, black
Measuring element material	Alloyed copper
Pointer material	Plastic, black
Motion work material	Alloyed copper
Pressure connection material	Alloyed copper
Dial	Plastic, white; with black lettering and pointer stop pin
Window	Plastic, crystal-clear; snap-fit
Measuring principle	Bourdon tube
Measurement range	Vacuum up to 25 bar
Accuracy class	2.5 according to EN 837 - 1
Display range	According to EN 837 - 1
Resting load	75 % of full scale value
Alternating load	67 % of full scale value
Short-term	100 % of full scale value
Pressure measuring element	Circular
Performance data	
Temperature behaviour	±0.4 % per 10 K related to +20 °C
Medium data	
Medium	Neutral/aggressive gases/liquids with small viscosity, those not crystallize and do not attack the materials of the bourdon tube
Medium temperature	Max. +60 °C
Environment and installation	
Ambient temperature	-20 to +60 °C

2. Dimensions

2.1. Dimensions pressure gauge with center back mount connection

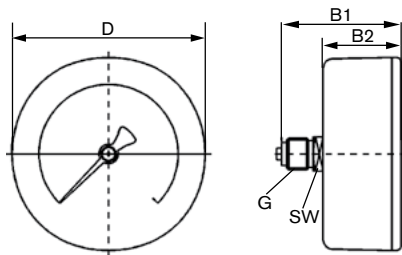

Nominal size	B1 ±0.5	B2 ±1.0	D	G	SW	Weight [kg]
40	44	26	41	G 1/8	14	0.063
50	47.5	26.5	49	G 1/4	14	0.071
63	48	27.5	62	G 1/4	14	0.078

2.2. Dimensions pressure gauge with radial lower mount connection

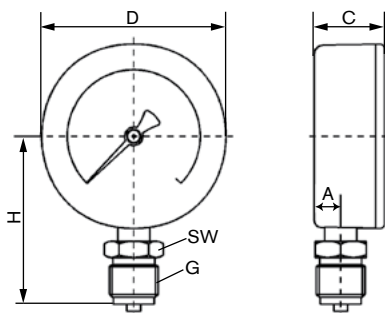

Nominal size	A	C ±0.5	D	G	H ±1.0	Flats	Weight [kg]
40	8	24.1	41	G 1/8	36	12	0.06
50	10	27.6	49	G 1/4	45	14	0.10
63	10	28.3	62	G 1/4	53.5	14	0.13

3. Ordering information

3.1. Bürkert eShop – Easy ordering and quick delivery



Bürkert eShop – Easy ordering and fast delivery

You want to find your desired Bürkert product or spare part quickly and order directly? Our online shop is available for you 24/7. Sign up and enjoy all the benefits.

[Order online now](#)

3.2. Bürkert product filter



Bürkert product filter – Get quickly to the right product













You want to select products comfortably based on your technical requirements? Use the Bürkert product filter and find suitable articles for your application quickly and easily.

[Try out our product filter](#)

3.3. Ordering chart pressure gauge with center back mount connection

Note:











Further versions on request

Display range [bar]	Nominal size [mm]	Process connection	Article no.
0 to 4	40	G 1/8	787028 
	50	G 1/4	787029 
	63	G 1/4	787030 
0 to 6	40	G 1/8	787031 
	50	G 1/4	787032 
	63	G 1/4	787033 
0 to 10	40	G 1/8	787034 
	50	G 1/4	787035 
	63	G 1/4	787036 
0 to 16	40	G 1/8	787037 
	50	G 1/4	787038 
	63	G 1/4	787039 

3.4. Ordering chart pressure gauge with radial lower mount connection

Note:

Further versions on request

Display range [bar]	Nominal size [mm]	Process connection	Article no.
0 to 4	40	G 1/8	787002 
	50	G 1/4	787003 
	63	G 1/4	787004 
0 to 6	40	G 1/8	787005 
	50	G 1/4	787006 
	63	G 1/4	787007 
0 to 10	40	G 1/8	787008 
	50	G 1/4	787009 
	63	G 1/4	787010 
0 to 16	40	G 1/8	787011 
	50	G 1/4	787012 
	63	G 1/4	787013 