





Pressure controller for precise time-pressure dosing

- Repeatable and accurate dosing of liquids in the μl range
- Response time in milliseconds and active pressure relief for optimum control performance
- Digital communication for easy integration into your fieldbus network
- Extended functionality through additional sensor input + actuator output e.g. for pump or additional pressure sensor
- Active vent valve to minimize consumption of costly carrier gas

Product variants described in the data sheet may differ from the product presentation and description.

Can be combined with

- 

Type 6712
2/2 way Whisper Valve with media separation
- 

Type 6724
2/2 or 3/2 way Whisper Valve with media separation
- 

Type ME43
Fieldbus gateway
- 

Type 6650 ▶
2/2 way Flipper-Solenoid Valve with separating diaphragm
- 

Type 8920
Bürkert Communicator

Type description

Time-pressure dosing is a widely used method for the reliable dosing of liquids across numerous fields of application. However, if dosing quantities are very small and the pressure differences between dosing cycles are minimal, closed-loop control becomes a challenge. Precisely the type of challenge for the pressure regulator Type 8763, which was specially developed for low flow rates and the resulting small dosing quantities. The device is characterised by short response times and precise closed-loop control of pressure. There are no down times or rejects at the beginning of dosing cycles. The digital interface makes it possible to access the various parameters at any time in order to change settings and read out data. Whether you are operating filling systems or state-of-the-art machines for genetic analysis and synthesis, a good valve alone is not enough. Precise pressure regulation is also essential for accuracy in time-pressure dosing. Only in this way can accurate dosing be implemented.

1. General technical data

Product properties	
Dimensions	Detailed information can be found in chapter "3. Dimensions" on page 5.
Performance data	
Gas control volume	30...3000 ml (adjustable from 2 ml)
Supply pressure p_1	0.2...3 bar / 2.9...43.5 Psi (supply pressure > target pressure) variants up to 2 bar control pressure 0.5...6 bar / 7.3...87.0 Psi (supply pressure > target pressure) variants up to 5 bar control pressure
Control range/Control accuracy in steady state	0.006...0.35 bar / 0.087...5.07 Psi (± 1.225 mbar / 0.0177 Psi) ^{1.)} 0.02...1.0 bar / 0.29...14.5 Psi (± 3.5 mbar / 0.05 Psi) ^{1.)} 0.04...2.0 bar / 0.058...29 Psi (± 7 mbar / 0.01 Psi) ^{1.)} 0.2...5.0 bar / 2.9...72.5 Psi (± 25 mbar / 362.6 Psi) ^{1.)}
Reproducibility + control accuracy according to Bürkert standard measuring setup ^{2.)}	< ± 0.35 % FS 0.35 to 2 bar variants < ± 0.75 % FS 5 bar variants
Temperature compensation	Yes
Reaction time	< 25 ms (sensor captures + adjustment of the control valve) Target pressure change 0...1 bar (0...14.5 Psi): 600 ms typical (supply pressure 3 bar (43.5 Psi) at 30 ml)
Electrical data	
Operating voltage	18...35 V DC
Power consumption (max.)	< 6 W (typically 2.4 W with connected additional loads < 12 W)
Connections	See "3. Dimensions" on page 5
Medium data	
Medium	Air Non-flammable, neutral gases (nitrogen, argon); oil-free
Medium temperature	+ 15...+ 40 °C
Process/Port connection & communication	
Input	G 1/8" or flange
Output controlled	UNF 1/4" - 28 or flange
Output switched (pressure relief)	Ventilation hole or flange
Approvals and certificates	
Protection class	IP20
Certified materials	On request
Environment and installation	
Ambient temperature	+ 15...+ 40 °C (for high control quality) Extension on request
Filter	36 μ m input filter

1.) In steady state means constant flow of medium

2.) 30 ml volume

2. Materials

2.1. Chemical Resistance Chart – Bürkert resistApp

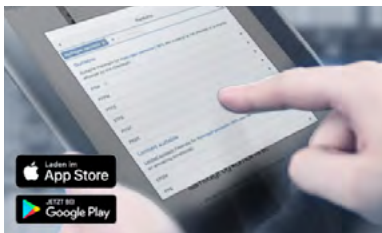

Bürkert resistApp – Chemical Resistance Chart

You want to ensure the reliability and durability of the materials in your individual application case? Verify your combination of media and materials on our website or in our resistApp.

[Start Chemical Resistance Check](#)

2.2. Materials in the fluid channel

The materials at the pressure inlet and at the pressure outlet are specified. In the case of venting, the materials of the pressure outlet are in direct contact with the media that may be degassing, i.e. PPS and FFKM.

The control is designed in such a way that when venting takes place through the core hole, out-gassed media are not in contact with the materials of the pressure input side, these are FKM, PTFE, brass and stainless steel.

Note:

Other materials are available on request.

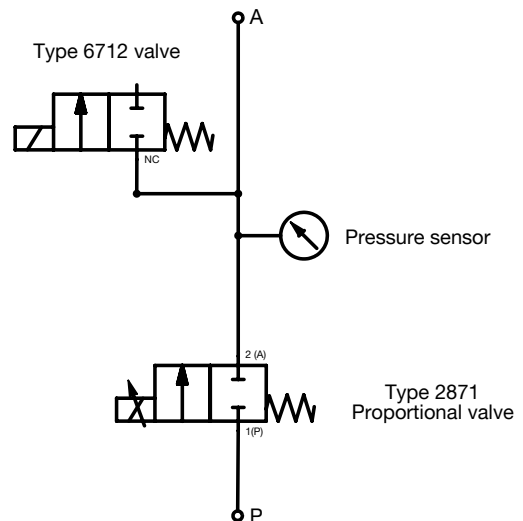
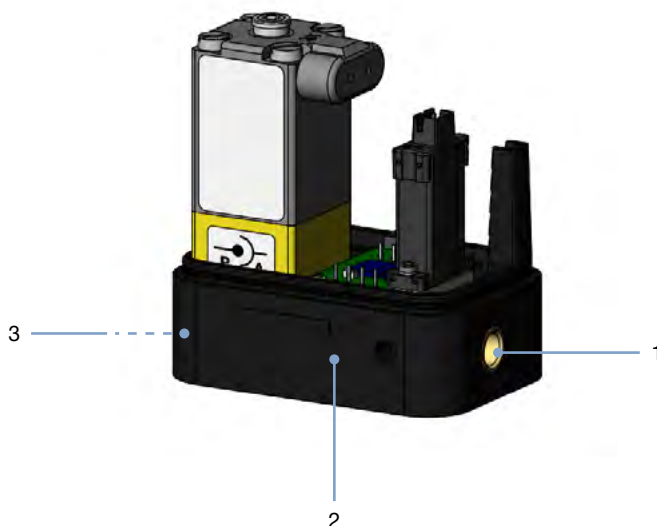

No.	Element	Material standard version	Material flange version
1	Pressure outlet	PPS and FFKM	PEEK, FFKM
2	Pressure sensor	Silicon, FKM	Silicon, FKM
3	Pressure input	Brass and stainless steel, FKM, PTFE	PTFE, brass or stainless steel, FKM

3. Dimensions

3.1. Digital/analog version with port connections

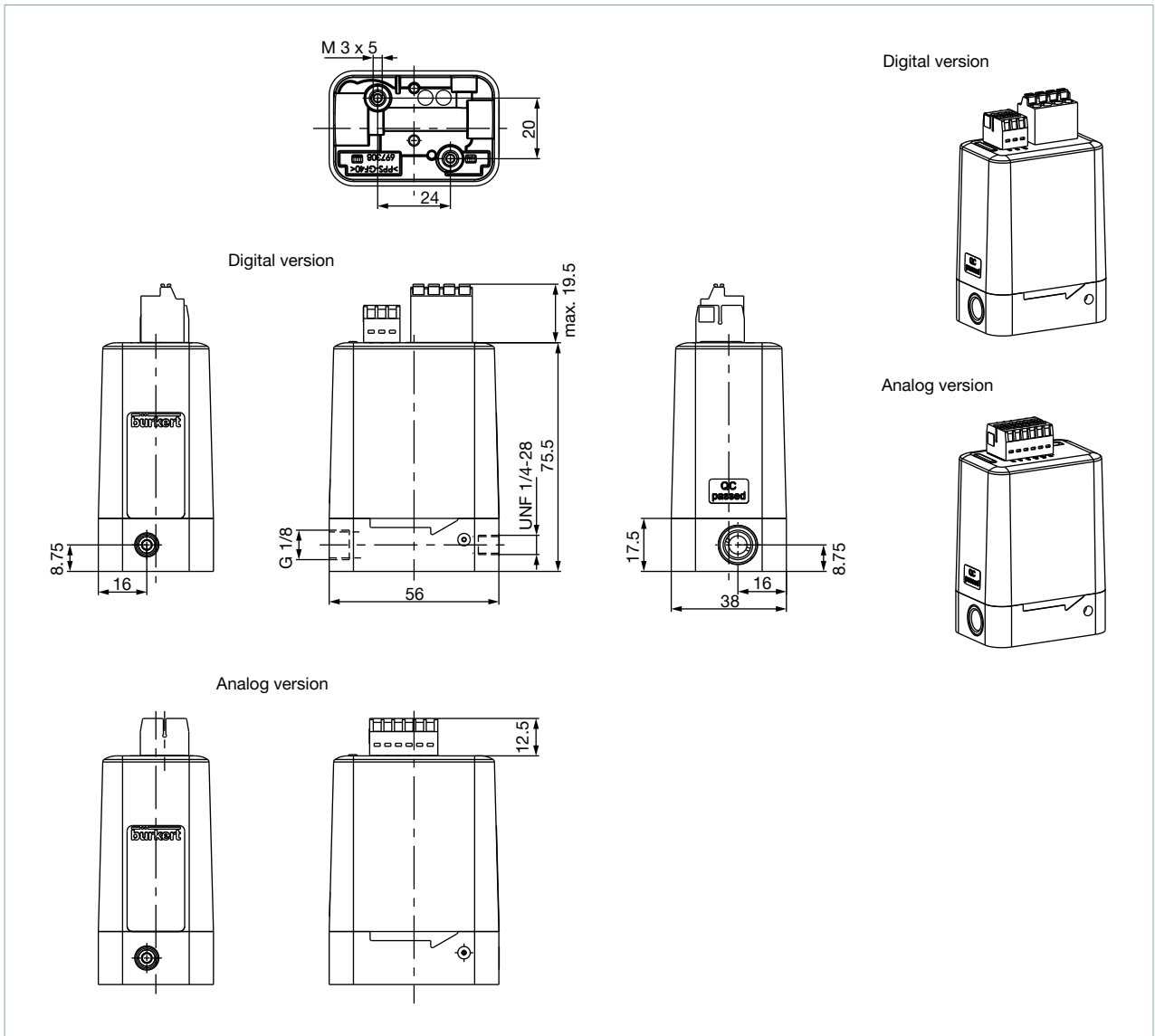

3.2. Flange versions (analog/digital)

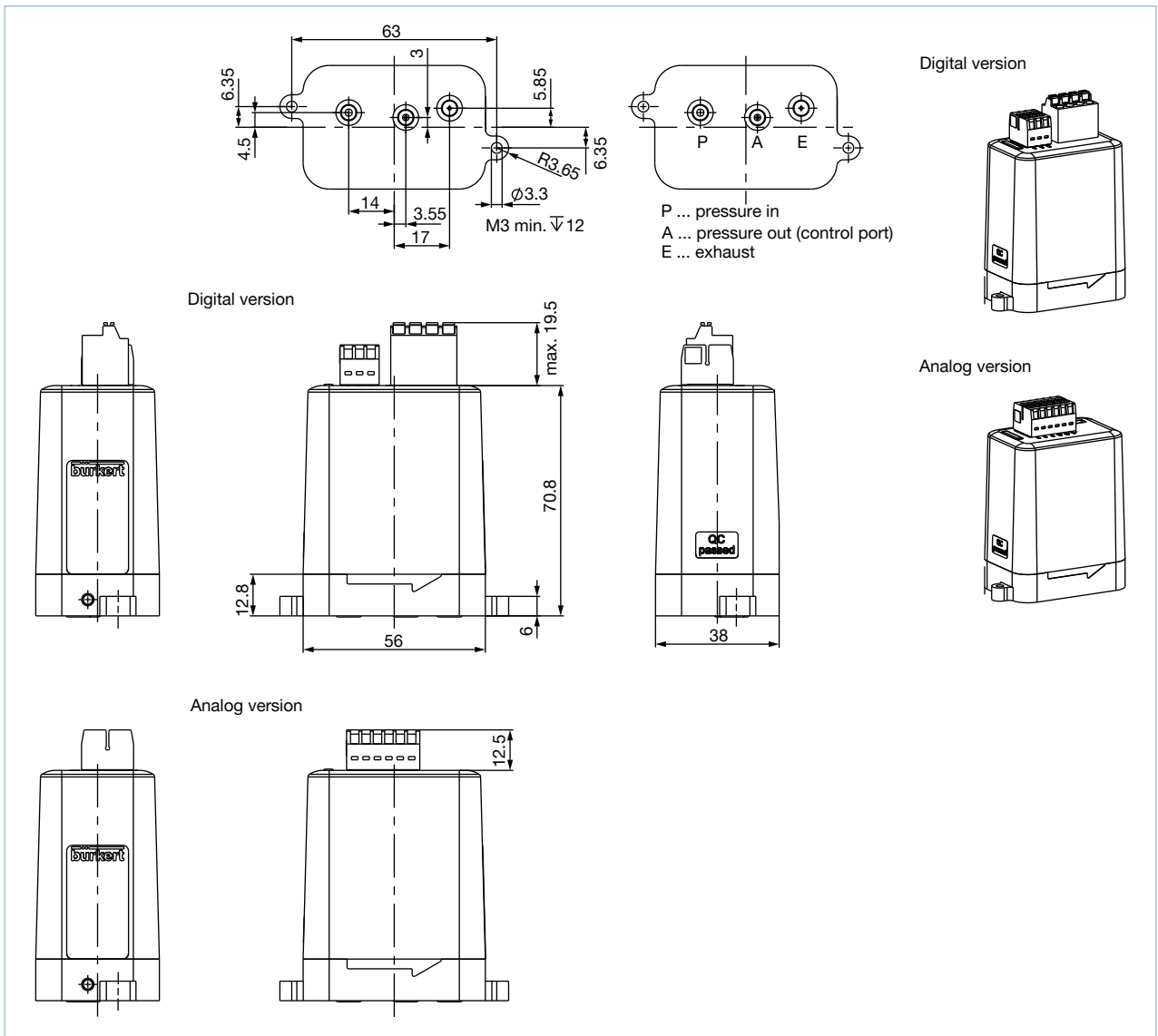

4. Device/Process connections

4.1. Electrical connections

Digital

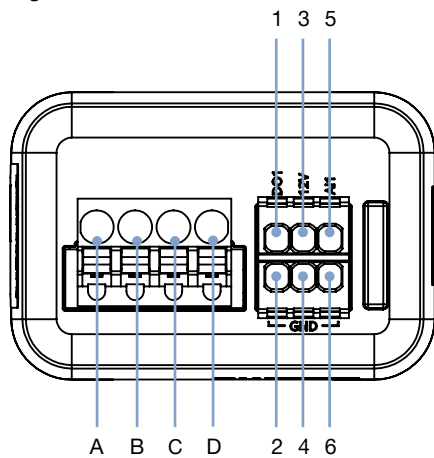

No.	Value
A	GND
B	CAN low
C	CAN high
D	18...35 V DC
1	DO1 12 V DC switchable e.g. pump
2	GND
3	Output voltage 12 V DC sensor supply
4	GND
5	AI1 (external sensor input)
6	GND

Analog

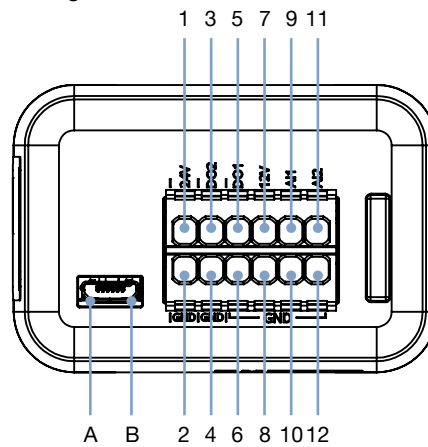

No.	Value	No.	Value
A	CAN high (Service büS)	6	GND
B	CAN low (Service büS)	7	Output voltage 12 V DC sensor supply
1	18...35 V DC	8	GND
2	GND	9	AI1 Analog In for sensor e.g. pump control
3	DO2 (Binary output)	10	GND
4	GND	11	AI2 Analog In for set pressure specification
5	DO1 12 V DC switchable e.g. pump	12	GND

5. Performance specifications

5.1. Dosing examples

General structure

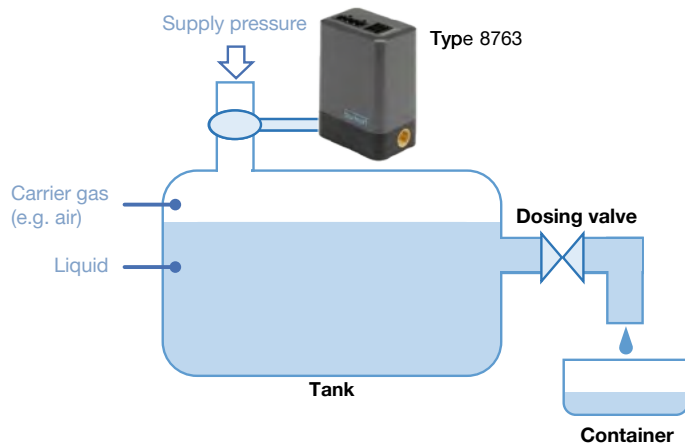

Dosing example for dosing time 50 ms

Type 8763 (Article no.: 318290)	
Parameter	Value
Supply pressure	2 bar (29 Psi)
Container air volume	50 ml
Dosing valve	Article no.: 273203
Dosing time/valve switching time	50 ms
Dosing medium	Water
Length of tank hose	500 mm
Cross-section of tank hose	2.36 mm
Hose length of tank dosing valve	350 + 200 mm
Hose cross-section of tank dosing valve	1.58 mm
Target pressure	138 mbar (2 Psi)
Dead band	0.05 %

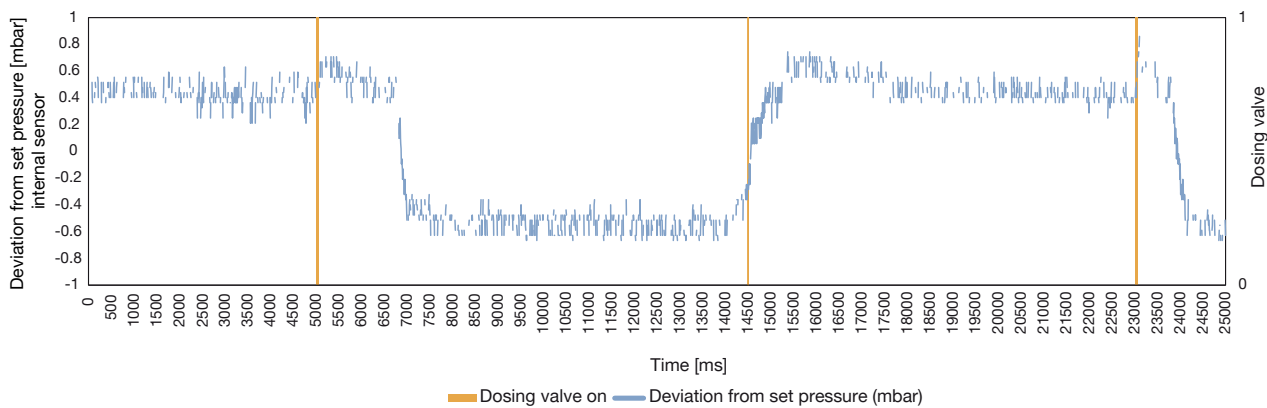

Dosing example for dosing time 500 ms

Type 8763 (Article no.: 318290)	
Parameter	Value
Supply pressure	2 bar (29 Psi)
Container air volume	50 ml
Dosing valve	Article no.: 273203
Dosing time/valve switching time	500 ms
Dosing medium	Water
Length of tank hose	500 mm
Cross-section of tank hose	2.36 mm
Hose length of tank dosing valve	350 + 200 mm
Hose cross-section of tank dosing valve	1.58 mm
Target pressure	500 mbar (7.25 Psi)
Dead band	0.05 %

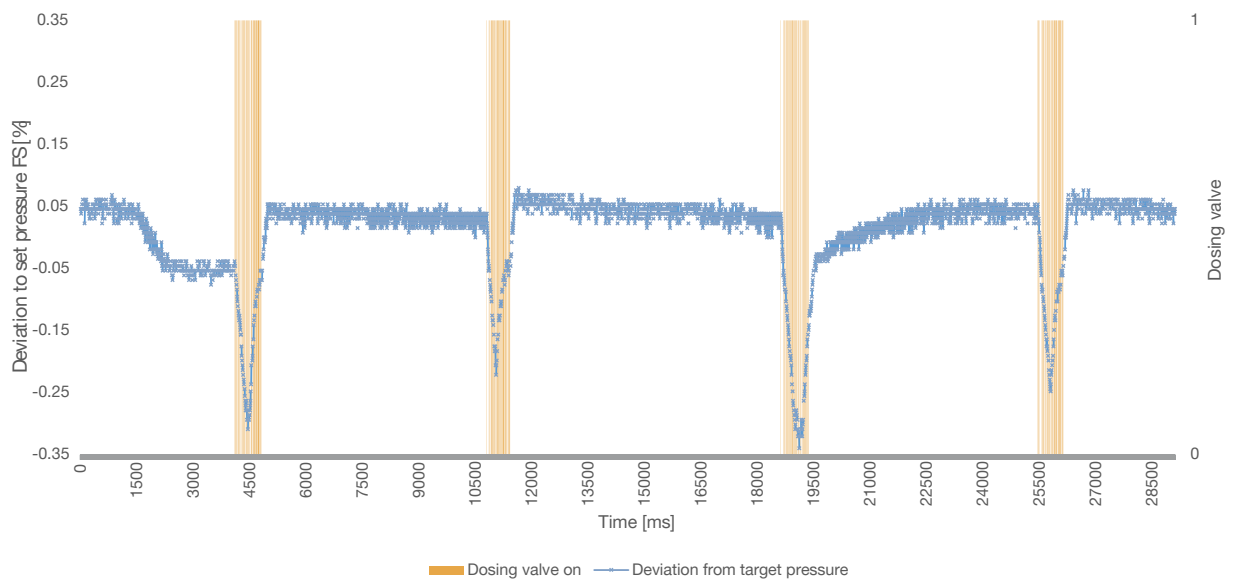

Dosing example for varying target pressure

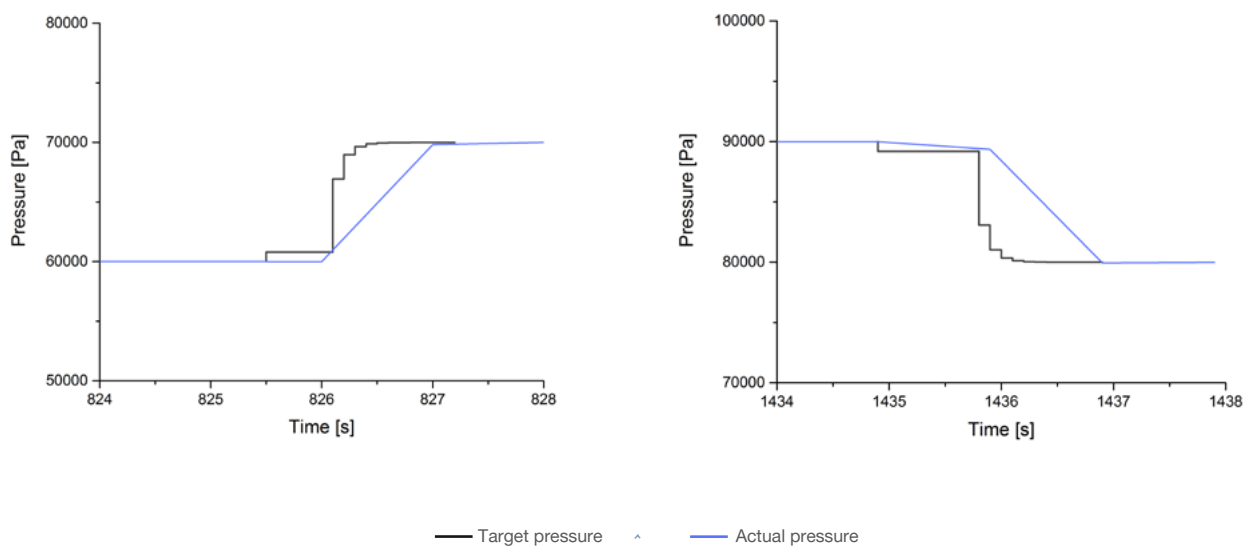

DTS 1000398869 EN Version: D Status: RL (released | freigegeben | validé) printed: 09.06.2021

5.2. Flow characteristic

Flow rate of versions with pressure ratio “target pressure to supply pressure”

Note:

How to determine the required flow rate (example) see following page.

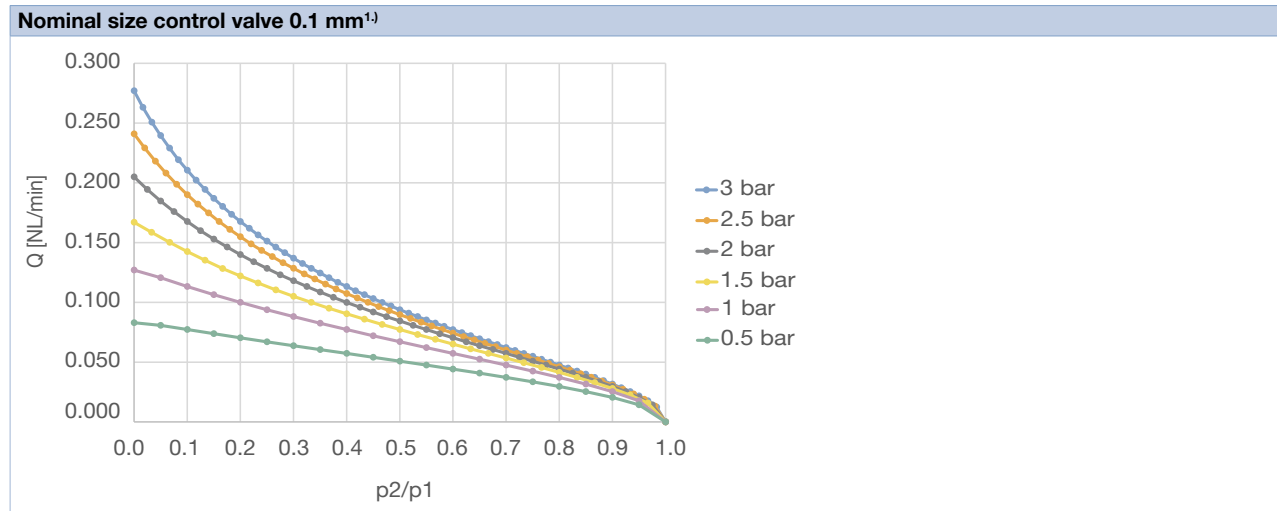

1.) p2 = target pressure; p1 = supply pressure

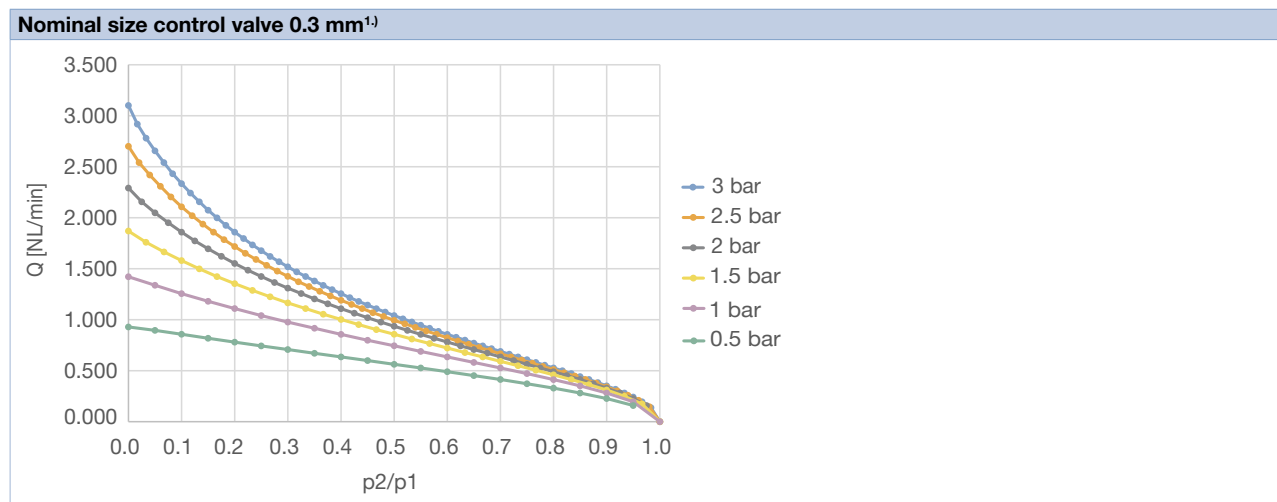

1.) p2 = target pressure; p1 = supply pressure

DTS 1000398869 EN Version: D Status: RL (released | freigegeben | validé) printed: 09.06.2021

How to determine the required flow rate (example)	
<p>Nominal size control valve 0.3 mm¹⁾</p>	<p>Calculation</p> <p>Sizing of the pressure regulator Below are some notes on sizing the supply pressure and target pressure to a desired dosing rate. It should be noted that real pressures must be higher because the calculation cannot consider the individual friction loss of the lines in the application.</p> <p>Step #1 Calculating the flow rate Example application with a dosing shot of 15 ms and 220 µl volume (220 µl / 15 ms) x 1000 = 14666 µl/s x 60 = 880000 µl/min = 0.88 l/min flow rate</p> <p>Step #2 Ratio target pressure / supply pressure DN 0.1 is too small → DN 0.3 mm minimum required Note: A low target pressure (300...500 mbar) has a beneficial effect on the dosing accuracy.</p> <p>Step #3 Determine supply pressure p1</p>

1.) p2 = target pressure; p1 = supply pressure

6. Ordering information

6.1. Bürkert eShop – Easy ordering and quick delivery



Bürkert eShop – Easy ordering and fast delivery

You want to find your desired Bürkert product or spare part quickly and order directly? Our online shop is available for you 24/7. Sign up and enjoy all the benefits.

[Order online now](#)

6.2. Bürkert product filter

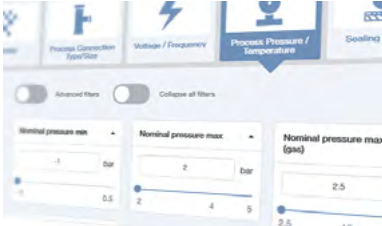

Bürkert product filter – Get quickly to the right product













You want to select products comfortably based on your technical requirements? Use the Bürkert product filter and find suitable articles for your application quickly and easily.

[Try out our product filter](#)

6.3. Ordering chart









Note:

All electrical plugs are included in the scope of delivery.

Pressure range [bar (Psi)]	Nominal size control valve ^{1.)} [mm]	Electrical connection	Fluidic connection Input/Output	Article no.
0.006...0.35 (0.087...5.08)	0.1	Analog	G 1/8 / UNF1/4...28	318289 
0.006...0.35 (0.087...5.08)	0.1	Digital	G 1/8 / UNF1/4...28	318288 
0.02...1 (0.3...14.5)	0.3	Analog	G 1/8 / UNF1/4...28	318292 
0.02...1 (0.3...14.5)	0.3	Digital	G 1/8 / UNF1/4...28	318290 
0.04...2 (0.6...29.0)	0.3	Analog	G 1/8 / UNF1/4...28	318293 
0.04...2 (0.6...29.0)	0.3	Digital	G 1/8 / UNF1/4...28	318291 
0.006...0.35 (0.087...5.08)	0.1	Analog	Flange pattern FB51	381013 
0.006...0.35 (0.087...5.08)	0.1	Digital	Flange pattern FB51	381012 
0.02...1 (0.3...14.5)	0.3	Analog	Flange pattern FB51	381018 
0.02...1 (0.3...14.5)	0.3	Digital	Flange pattern FB51	381015 
0.04...2 (0.6...29.0)	0.3	Analog	Flange pattern FB51	381019 
0.04...2 (0.6...29.0)	0.3	Digital	Flange pattern FB51	381017 
0.2...5 (2.9...72.5)	0.3	Digital	Flange pattern FB51	393266 

1.) Other versions on request

6.4. Ordering chart accessories

Description	Article no.
büS starter kit 	772426 
Connector, digital version (büS)	920299 
Connector, digital version (sensor supply/actuator)	920245 
Plug, analogue version	920225 
Connection plate for 8763 flange pattern FB51 with three G 1/8 port connections	394687 
Gas/air pump SP 570 EC 12 V DC (250 mA); ≥2 l/min; ≥1000 mbar (14.5 Psi)	906327 
Gas/air pump SP 600 EC-DV 12 V DC (400 mA); ≥3 l/min; ≥1300 mbar (18.85 Psi)	906379 
Gas/air pump SP 620 EC-BL-DV 12 V DC (500 mA) ≥2.8 l/min; ≥1300 mbar (18.85 Psi); brushless	906380 