

По вопросам продаж и поддержки обращайтесь:

Архангельск (8182)63-90-72	Краснодар (861)203-40-90	Рязань (4912)46-61-64
Астана (7172)727-132	Красноярск (391)204-63-61	Самара (846)206-03-16
Белгород (4722)40-23-64	Курск (4712)77-13-04	Санкт-Петербург (812)309-46-40
Брянск (4832)59-03-52	Липецк (4742)52-20-81	Саратов (845)249-38-78
Владивосток (423)249-28-31	Магнитогорск (3519)55-03-13	Смоленск (4812)29-41-54
Волгоград (844)278-03-48	Москва (495)268-04-70	Сочи (862)225-72-31
Вологда (8172)26-41-59	Мурманск (8152)59-64-93	Ставрополь (8652)20-65-13
Воронеж (473)204-51-73	Набережные Челны (8552)20-53-41	Тверь (4822)63-31-35
Екатеринбург (343)384-55-89	Нижний Новгород (831)429-08-12	Томск (3822)98-41-53
Иваново (4932)77-34-06	Новокузнецк (3843)20-46-81	Тула (4872)74-02-29
Ижевск (3412)26-03-58	Новосибирск (383)227-86-73	Тюмень (3452)66-21-18
Казань (843)206-01-48	Орел (4862)44-53-42	Ульяновск (8422)24-23-59
Калининград (4012)72-03-81	Оренбург (3532)37-68-04	Уфа (347)229-48-12
Калуга (4842)92-23-67	Пенза (8412)22-31-16	Челябинск (351)202-03-61
Кемерово (3842)65-04-62	Пермь (342)205-81-47	Череповец (8202)49-02-64
Киров (8332)68-02-04	Ростов-на-Дону (863)308-18-15	Ярославль (4852)69-52-93

Единый адрес: btk@nt-rt.ru **Веб-сайт:** www.burkert.nt-rt.ru

Отсечные мембранные пневмоклапаны Burkert

Tank Bottom Valve, pneumatically operated



- Fully integrated in Bürkert's Process Control Systems
- Monoblock – no welds
- Quality certifications 

Type 2033 can be combined with...



Type 8697

Electrical position feedback



Stroke limitation

Min./max. stroke limitation



Type 6012

Pilot valve

For process valves with decentralized automation see ELEMENT Type 2105



The Bürkert Tank Bottom Valve system is designed for control of ultra pure, sterile, aggressive or abrasive fluids. Enables especially optimal filling and emptying vessels with less dead leg.

The valve body consists of a block with no weld seam, machined out of high quality stainless steel. The Tank Bottom Valve has two welding levels to ease the welding and valve positioning operations.

The high quality diaphragms separate hermetically critical fluids from the actuator. The pneumatic actuator can be controlled by pneumatic pilot valves (single pilot valves, valve islands and control heads). Control function A, normally closed by spring return.

Technical data		
Orifice	DN08 to DN100	
Body material	Stainless steel 1.4435 acc. to BN2 / ASME BPE Fe < 0.5% / C ≤ 0.03%	
Port connections	<ul style="list-style-type: none"> • DIN EN ISO 1127 / ISO 4200 / DIN 11866 Series B • DIN 11850 Series 2 / DIN 11866 Series A • ASME BPE / DIN 11866 Series C • DIN 32676 Series A (DIN tube) • DIN 32676 Series B (ISO tube) • ASME BPE 	
Weld end		
Clamp		
Surface finish	Ra [µm] internal	Ra [µlnch] internal
mechanical polished	≤0.5	≤25
electro polished	≤0.38	≤15
mirror finished ¹⁾	0.25	10
Diaphragm materials	EPDM (AB), PTFE/EPDM (EA) EPDM (AD), advanced PTFE/EPDM (EU) and FKM (FF) on request	
Actuator material	PPS (PA for actuator sizes ø 175/225 mm)	
Medium temperatures	EPDM (AB), PTFE/EPDM (EA) -10 to +130 °C (steam sterilisation +140 °C for 60 min) EPDM (AD), advanced PTFE/EPDM (EU) -5 to +143 °C (steam sterilisation +150 °C for 60 min) EPDM (EU) FKM (FF) 0 to +130 °C (not recommended for steam)	
Ambient temperature	Actuator size < 100 mm +5 to +140 °C Actuator size ≥ 100 mm +5 to +90 °C (briefly up to +140 °C, -10 to +60 °C with PA actuator)	
Control medium	Neutral gases, air	
Pilot pressure max.	max. 7 bar, see table on page 2	

¹⁾ Internal Ra < 0.1 µm/4 µlnch/500 Grit: on request

Content

Valve specifications	System spec. On/Off CLASSIC	Request for quotation
Type 2033	Type 8801-DG	Type 8801-DG
Technical data & ordering info. p. 1-5	Ordering info. & Technical data p. 6-8	p. 9

Technical data, *continued*

Orifice [mm]	Actuator size Ø [mm]	Kv-value water [m ³ /h]	Pilot pressure [bar]	Max. operating pressure (medium) for seal material	
				EPDM, FKM [bar]	PTFE/EPDM, advanced PTFE/EPDM [bar]
8	40	1.0	5.0-7	10	10
15	50	4.0	5.0-7	8,5	5
	63	4.5	5.0-7	10	10
20	63	7.0	5.5-7	10	5
	80	7.5	5.0-7	10	10
25	80	12.0	5.5-7	10	7.5
40	100	30.0	5.5-7	6.5	6
	125	30.5	5.5-7	10	10
50	125	51.5	5.5-7	8	7
80	175	160.0	5.0-7	5	4.5
	225	160.0	5.0-7	10	10
100	225	235.0	5.0-7	8	4

Materials

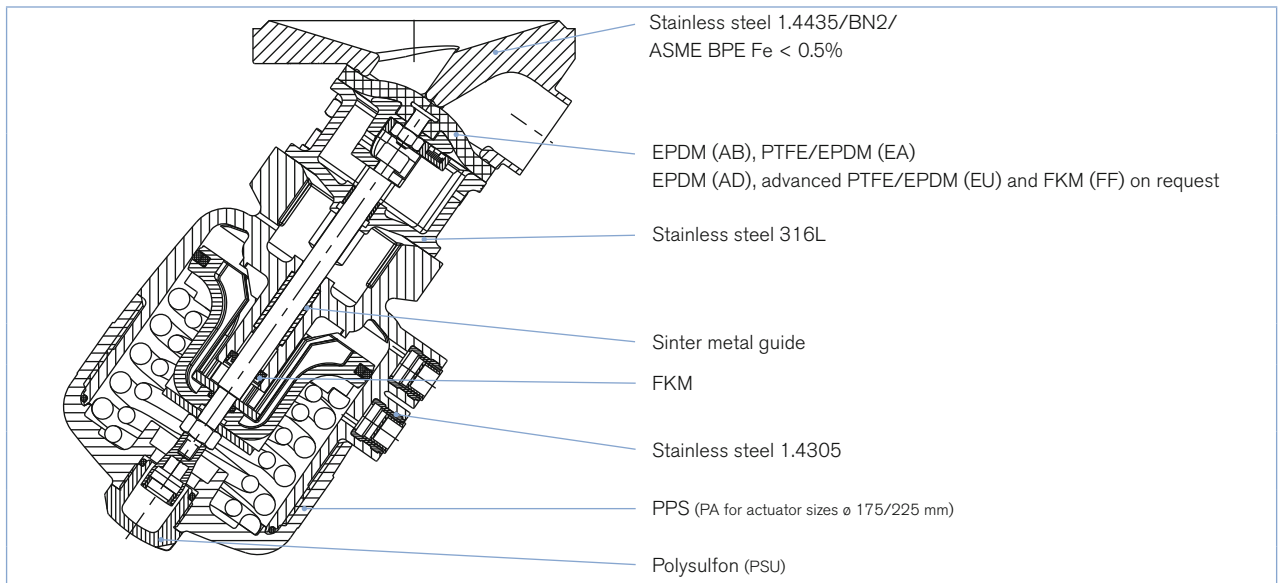

Approvals

Suitability for foodstuffs / sterile applications



- The composition of the EPDM (AB), EPDM (AD), PTFE/EPDM (EA) and advanced PTFE (EU) diaphragms corresponds to the Code of Federal Regulations, published by the FDA (Food and Drug Administration, USA).



- The composition of the EPDM (AB), EPDM (AD), PTFE/EPDM (EA) and advanced PTFE (EU) diaphragms is suitable for the application with food and beverage (acc. to EC-Regulation 1935/2004/EC)
- The composition of the EPDM (AB), EPDM (AD), PTFE/EPDM (EA) und advanced PTFE (EU) diaphragms are approved acc. USP Class VI
- Approval according to TA-air (Port size DN4-50)

Example of available diaphragm materials

Developed to handle the unique challenges of hygienic and sterile applications, Bürkert offers diaphragms with precise material formula and physical tolerances. Bürkert diaphragms are available in a wide range of materials which have been proven in food & beverage, biotechnology, pharmaceutical and cosmetic industry applications. Diaphragms are tested during development and production to ensure reliability in critical processing environments.



- EPDM (AB)
- EPDM (AD)
- PTFE/EPDM (EA)
- advanced PTFE/EPDM (EU)
- FKM (FF)

Dimensions [mm]

Body with weld end

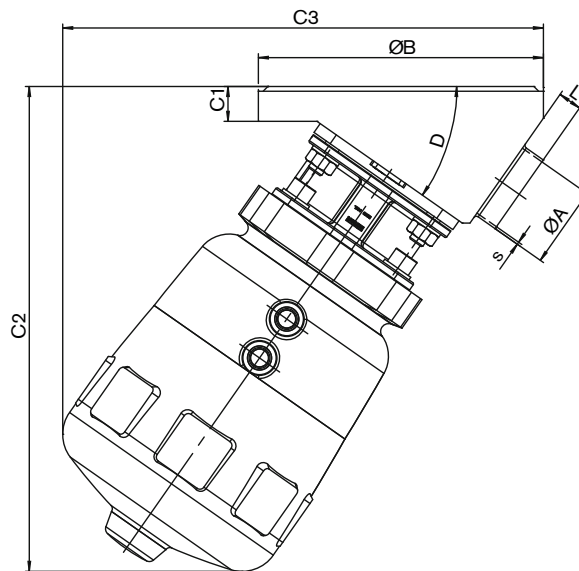

EN ISO 1127 / ISO 4200

Orifice [mm]	Port connection [mm]	Actuator size [mm]	ØA	s	ØB	C1	C2	C3	D	L
08	08	40	13.5	1.6	50	8	107	100	35°	5
15	15	50	21.3	1.6	65	12	146	134	35°	3
		63			85		160	147		8
20	20	63	26.9	1.6	85	12	171	160	35°	5.6
		80					190	179		
25	25	80	33.7	2	120	16	183	174	35°	8
		100					200	192		
40	32	100	42.4	2	150	18	258	260	35°	20
	40	100	48.3	2			258	260	35°	15
		125					293	291		
50	50	125	60.3	2	180	22	306	304	35°	12
80	65	175	76.1	2	225	20	388	422	40°	16
	80		88.9	2.3			388	422		10
100	100	225	114.3	2.3	298	30	436	481	40°	11

Dimensions [mm], *continued*Body with weld end, *continued*

ASME BPE										
Orifice [mm]	Port connection [mm]	Actuator size [mm]	øA	s	øB	C1	C2	C3	D	L
08	08	40	6.35	0.89	50	8	107	100	35°	9
15	15	50	12.7	1.65	85	12	146	134	35°	10
		63					160	147		
20	20	63	19.05	1.65	85	12	171	160	35°	8
		80					190	179		
25	25	63	25.4	1.65	120	16	183	174	35°	8
		80					200	192		
40	40	100	38.1	1.65	150	18	258	260	35°	15
		125					293	291		
50	40	125	38.1	1.65	180	22	306	304	35°	25
	50	125	50.8	1.65						15
	65	125	63.5	1.65						11
80	65	175	63.5	1.65	225	20	388	422	40	25
	80	175	76.2	1.65	225	20	388	422	40°	16
100	100	225	101.6	2.11	298	30	436	481	40°	14

DIN 11850 / RG2										
Orifice [mm]	Port connection [mm]	Actuator size [mm]	øA	s	øB	C1	C2	C3	D	L
08	10	40	13	1.5	50	8	107	100	35°	6
15	15	50	19	1.5	85	12	146	134	35°	8
		63					160	147		
20	20	63	23	1.5	85	12	171	160	35°	7
		80					190	179		
25	25	63	29	1.5	120	16	183	174	35°	8
		80					200	192		
40	40	100	41	1.5	150	18	258	260	35°	20
		125					293	291		
50	50	125	53	1.5	180	22	306	304	35°	15
80	80	175	85	2.0	225	20	388	422	40°	16
100	100	225	104	2	298	30	436	481	40°	14

Dimensions [mm], *continued*

Clamp Body

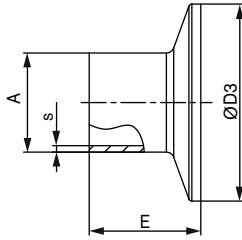

ASME BPE

Orifice [mm]	Orifice [inch]	A	s	D3	E
08	1/4"	6.35	0.89	25.0	28.6
10	3/8"	9.53	0.89	25.0	28.6
15	1/2"	12.7	1.65	25.0	28.6
20	3/4"	19.05	1.65	25.0	28.6
25	1"	25.4	1.65	50.5	28.6
40	1 1/2"	38.1	1.65	50.5	28.6
50	2"	50.8	1.65	64.0	28.6
65	2 1/2"	63.5	1.65	77.5	28.6
80	3"	76.2	1.65	91.0	28.6
100	4"	101.6	2.11	119.0	28.6

DIN 32676

Orifice [mm]	A	s	D3	E
10	13	1.5	34.0	18
15	19	1.5	34.0	18
20	23	1.5	34.0	18
25	29	1.5	50.5	21.5
32	35	1.5	50.5	21.5
40	41	1.5	50.5	21.5
50	53	1.5	64.0	21.5
65	70	2.0	91.0	28

DIN 32676 series B for pipe ISO 4200

Orifice [mm]	A	s	D3	E
8	13.5	1.6	25.0	28.6
8	13.5	1.6	34.0	28.6
10	17.2	1.6	34.0	28.6
15	21.3	1.6	34.0	28.6
15	21.3	1.6	50.5	28.6
20	26.9	1.6	50.5	28.6
25	33.7	2	50.5	28.6
32	42.4	2	50.5	28.6
40	48.3	2	64.0	28.6
50	60.3	2	77.5	28.6
65	76.1	2	91.0	28.6
80	88.9	2.3	106.0	28.6
100	114.3	2.3	130.0	28.6

SMS

Orifice [mm]	A	s	D3	E
25	25	1.2	50.5	21.5
40	38	1.2	50.5	28.6
50	51	1.2	64.0	28.6

Ordering information for valve system On/Off CLASSIC Type 8801-DG



A **Tank bottom valve Type 2033** can be combined with the **feedback Type 8697** to form a **valve system On/Off CLASSIC**.

The valve system On/Off CLASSIC is composed of:

- a feedback **Type 8697** (see separate datasheet) [More info.](#)
- an diaphragm valve **Type 2033** (see ordering chart p. 6)

For the configuration of further valve systems please use the "Request for quotation" on p. 9. [go to page](#)

You order two components and receive a complete assembled and certified valve.

<p>Tank bottom vane Type 2033</p> 	<p>Feedback Type 8697</p> 
<p>Valve System On/Off CLASSIC</p>  <p>Typ 8801-DG-U 2033 + 8697</p>	

Electrical position feedback [More info.](#)



Type 8697
Actuator size 40 to 225

The pneumatic control unit Type 8697 is designed for integrated mounting on CLASSIC series 20XX process valves suiting the requirements of hygienic process environment Mechanical or inductive limit switches register the position of the valve.

Features

- Compact design
- LED position indicator
- Mechanical or inductive limit switches for end position registering
- Easy to clean chemically resistant housing featuring IP65 / IP67, 4X Rating
- Optional intrinsically safe version acc. to ATEX

Benefits

- Easy and quick installation
- High level of signal reliability thanks to self adjusting limit switches
- Signal safety through the automatic adjustment of the limit switches
- Minimised space requirement in the plant piping for more flexibility in plant design

Click on the orange box „More info“... you will come to our website for the resp. product where you can download the data sheet.

Dimensions for valve system On/Off Classic Type 8801-DG [mm]

Dimensions valve system On/Off Classic Type 8801-DG with electrical position feedback Type 8697

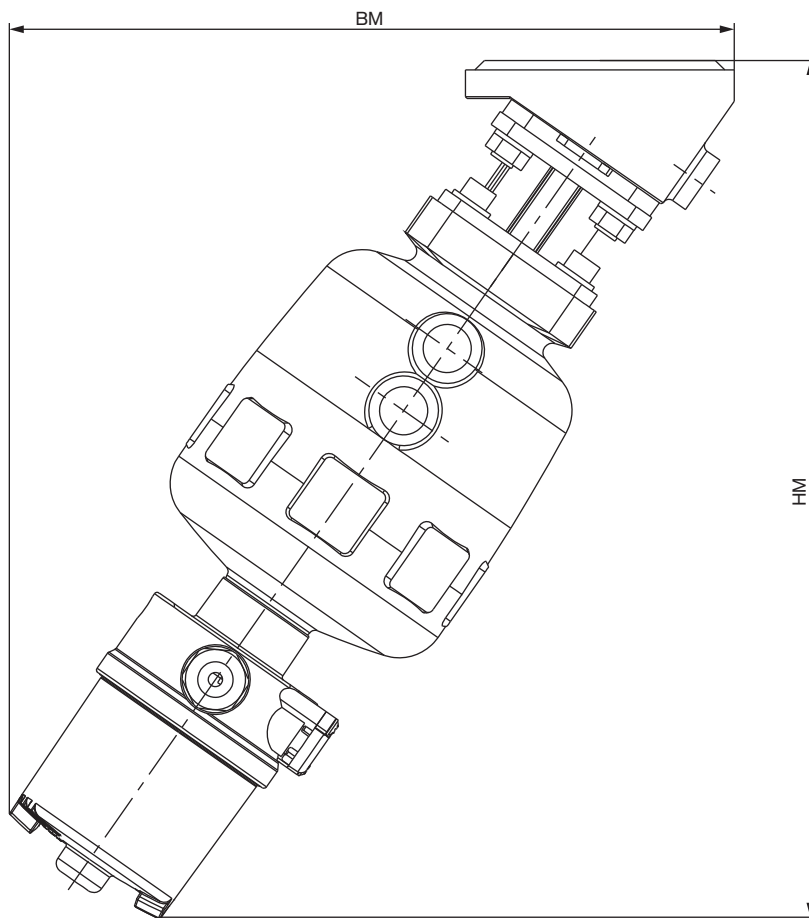

Connection	Orifice [mm]	Actuator size [mm]	BM	HM
Weld end EN ISO 1127/ ISO 4200/ ASME BPE/ DIN 11850/ RG2	15	50	194	228
		63	201	239
	20	63	226	267
		80	229	271
	25	80	238	277
	40	100	300	337
		125	318	363
	50	125	333	374
	80	175	443	427
		175	433	419
100	225	455	463	

Valve features, specification

Example

2033 A 15 EU B VI F085 SA42 D E NK52 + N023

Specification key

Please make a choice

CONTROL FUNCTION

A	normally closed by spring action
B	normally open by spring action
I	double acting

ORIFICE [mm] (diaphragm)

08	40
15	50
20	80
25	100

SEAL MATERIAL

AB	EPDM in food quality
AD	EPDM
EA	PTFE
FF	FKM
EU	advanced PTFE

PRODUCTION OF BODY

B	Bloc material
---	---------------

BODY MATERIAL

VH	1.4435/AISI 316L
VI	1.4435BN2/ASME BPE

TANK FLANGE

F050	DN08 (ø 50 mm)
F085	DN15 (ø 85 mm)
F085	DN20 (ø 85 mm)
F120	DN25 (ø 120 mm)
F150	DN40 (ø 150 mm)
F180	DN50 (ø 180 mm)
F225	DN80 (ø 225 mm)
F300	DN100 (ø 298 mm)

VARIABLE CODES

Surface finish external	
NO34	Ext. mechanical polished Ra=1.2 µm

Surface finish, internal	
NO14	Int. mechanical polished Ra=0.5 µm
NO17	Int. electro polished Ra=0.38 µm

Certificate	
NK52	3.1 Certificate

ACTUATOR SIZE ¹⁾

C	ø 40 mm
D	ø 50 mm
E	ø 63 mm
F	ø 80 mm
G	ø 100 mm
H	ø 125 mm
K	ø 175 mm
L	ø 225 mm

¹⁾ for technical spec. see table, page 2

ACTUATOR MATERIAL

C	PA (for actuator sizes ø175/225 mm)
D	PPS

Standard



DN [mm]	Port connection weld end							
	EN ISO 1127/ ISO 4200 DIN 11866 S. B	SMS 3008	DIN 11850 S. 0	DIN 11850 S. 1	DIN 11850 S. 2 DIN 11866 S. A	DIN 11850 S. 3	BS4825	ASME BPE DIN 11866 S. C
4			SC40 - 6,0x1,0					
6	SA78 - 10,2x1,6		SC41 - 8,0x1,0					SA89 - 3,17x0,56
8	SA40 - 13,5x1,6		SC42 - 10,0x1,0				SODB - 6,35x1,2	SA90 - 6,35x0,89
10	SA41 - 17,2x1,6			SF40 - 12,0x1,0	SD40 - 13,0x1,5	SE40 - 14,0x2,0	SODC - 9,53x1,2	SA91 - 9,53x0,89
15	SA42 - 21,3x1,6	SA58 - 12,0x1,0	SC43 - 18,0x1,5	SF41 - 18,0x1,0	SD42 - 19,0x1,5	SE42 - 20,0x2,0	SODD - 12,7x1,2	SA92 - 12,7x1,65
20	SA43 - 26,9x1,6	SA59 - 18,0x1,0	SC44 - 22,0x1,5	SF42 - 22,0x1,0	SD43 - 23,0x1,5	SE43 - 24,0x2,0	SODE - 19,05x1,2	SA93 - 19,05x1,65
25	SA44 - 33,7x2,0	SA60 - 25,0x1,2	SC45 - 28,0x1,5	SF43 - 28,0x1,0	SD44 - 29,0x1,5	SE44 - 30,0x2,0		SODF - 25,4x1,65
32	SA45 - 42,4x2,0	SA61 - 33,7x1,2	SC46 - 34,0x1,5	SF44 - 34,0x1,0	SD45 - 35,0x1,5	SE45 - 36,0x2,0		
40	SA46 - 48,3x2,0	SA62 - 38,0x1,2	SC47 - 40,0x1,5	SF45 - 40,0x1,0	SD46 - 41,0x1,5	SE46 - 42,0x2,0		SODH - 38,1x1,65
50	SA47 - 60,3x2,0	SA63 - 51,0x1,2	SC48 - 52,0x1,5	SF46 - 52,0x1,0	SD47 - 53,0x1,5	SE47 - 54,0x2,0		SODI - 50,8x1,65
65	SA48 - 76,1x2,0	SA64 - 63,5x1,6			SD48 - 70,0x2,0			SODJ - 63,5x1,65
80	SA49 - 88,9x2,3	SA65 - 76,1x1,6			SD49 - 85,0x2,0			SODK - 76,2x1,65
100	SA39 - 114,3x2,3	SA66 - 101,6x2,0			SD50 - 104,0x2,0			SODL - 101,6x2,11
DN [mm]	Port connection Clamp							
	Clamp 34,0 like DIN 32676 S. B (ISO-tube (ISO4200))	DIN 32676 S. A (DIN-tube (DIN11850))	DIN 32676 S. B (ISO-tube (ISO4200))	ASME BPE	BS 4825 (Clamp BS 4825-3, tube BS 4825-1)			
8	TC51 - 13,5x1,6 Ci: 34,0	TD40 - 10,0x1,0 Ci: 25,0	TC40 - 13,5x1,6 Ci: 25,0	TG50 - 6,35x0,89 Ci: 25,0				
10	TC41 - 17,2x1,6 Ci: 34,0	TD41 - 13,0x1,5 Ci: 34,0	TC53 - 17,2x1,6 Ci: 25,0	TG01 - 9,53x0,89 Ci: 25,0				
15	TC42 - 21,3x1,6 Ci: 34,0	TD42 - 19,0x1,5 Ci: 34,0	TC52 - 21,3x1,6 Ci: 50,5	TG02 - 12,7x1,65 Ci: 25,0	TH42 - 12,7x1,2 Ci: 25,0			
20		TD43 - 23,0x1,5 Ci: 34,0	TC43 - 26,9x1,6 Ci: 50,5	TG03 - 19,05x1,65 Ci: 25,0	TH43 - 19,05x1,2 Ci: 25,0			
25		TD44 - 29,0x1,5 Ci: 50,5	TC44 - 33,7x2,0 Ci: 50,5	TG04 - 25,4x1,65 Ci: 50,5				
32								
40		TD46 - 41,0x1,5 Ci: 50,5	TC46 - 48,3x2,0 Ci: 64,0	TG05 - 38,1x1,65 Ci: 50,5				
50		TD47 - 53,0x1,5 Ci: 64,0	TC47 - 60,3x2,0 Ci: 77,5	TG06 - 50,8x1,65 Ci: 64,0				
65			TC48 - 76,1x2,0 Ci: 91,0	TG07 - 63,5x1,65 Ci: 77,5				
80			TC49 - 88,9x2,3 Ci: 106,0	TG08 - 76,2x1,65 Ci: 91,0				
100			TC50 - 114,3x2,3 Ci: 130,0	TG09 - 101,6x2,11 Ci: 119,0				

Valve system On/Off Classic Type 8801-DG – request for quotation, *continued*

Valve accessories	
Pilot valve <input type="checkbox"/> Pilot valve Power supply <input type="text"/> Please specify item no. (if known): <input type="text"/>	Control Stroke limitation <input type="checkbox"/> Stroke limitation <input type="checkbox"/> Min./max. stroke without visual position indicator <input type="checkbox"/> Max. stroke without visual position indicator Please specify item no. (if known): <input type="text"/>
Certifications	
<input type="checkbox"/> Attestation of compliance with the order EN-ISO 10204 2.1 (Item-No. 440 788)	<input type="checkbox"/> EN161 (European Gas Device guideline)
<input type="checkbox"/> Test report EN-ISO 10204 2.2 (Item-No. 803 722)	<input type="checkbox"/> FDA and USP compliance
<input type="checkbox"/> Certification of Conformity for Raw Material EN-ISO 10204 3.1 (Included in delivery)	
Comment	
<hr/> <hr/> <hr/> <hr/> <hr/>	

*To find your nearest Bürkert facility, click on the orange box → 