

**По вопросам продаж и поддержки обращайтесь:**

Архангельск (8182)63-90-72	Краснодар (861)203-40-90	Рязань (4912)46-61-64
Астана (7172)727-132	Красноярск (391)204-63-61	Самара (846)206-03-16
Белгород (4722)40-23-64	Курск (4712)77-13-04	Санкт-Петербург (812)309-46-40
Брянск (4832)59-03-52	Липецк (4742)52-20-81	Саратов (845)249-38-78
Владивосток (423)249-28-31	Магнитогорск (3519)55-03-13	Смоленск (4812)29-41-54
Волгоград (844)278-03-48	Москва (495)268-04-70	Сочи (862)225-72-31
Вологда (8172)26-41-59	Мурманск (8152)59-64-93	Ставрополь (8652)20-65-13
Воронеж (473)204-51-73	Набережные Челны (8552)20-53-41	Тверь (4822)63-31-35
Екатеринбург (343)384-55-89	Нижний Новгород (831)429-08-12	Томск (3822)98-41-53
Иваново (4932)77-34-06	Новокузнецк (3843)20-46-81	Тула (4872)74-02-29
Ижевск (3412)26-03-58	Новосибирск (383)227-86-73	Тюмень (3452)66-21-18
Казань (843)206-01-48	Орел (4862)44-53-42	Ульяновск (8422)24-23-59
Калининград (4012)72-03-81	Оренбург (3532)37-68-04	Уфа (347)229-48-12
Калуга (4842)92-23-67	Пенза (8412)22-31-16	Челябинск (351)202-03-61
Кемерово (3842)65-04-62	Пермь (342)205-81-47	Череповец (8202)49-02-64
Киров (8332)68-02-04	Ростов-на-Дону (863)308-18-15	Ярославль (4852)69-52-93

**Единый адрес:** [btk@nt-rt.ru](mailto:btk@nt-rt.ru) **Веб-сайт:** [www.burkert.nt-rt.ru](http://www.burkert.nt-rt.ru)

# Отсечные мембранные пневмоклапаны Burkert

## Tank Bottom Valve, pneumatically operated



- Fully integrated in Bürkert's Process Control Systems
- Monoblock – no welds
- Quality certifications 

Actuator  
with 360°  
rotation  
possibility

Type 2105 can be combined with...



**Type 8691**  
Control Head



**Type 8695**  
Control Head



**Type 8690**  
Pneumatic  
Control Unit



**Type 8697**  
Pneumatic  
Control Unit



**Stroke limitation**  
Max./min.  
stroke limitation

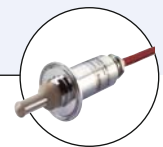

**Type 8221**  
Conductivity  
sensor

The Bürkert Tank Bottom Valve system is designed for control of ultra pure, sterile, aggressive or abrasive fluids. Enables especially optimal filling and emptying vessels with less dead leg.

The valve body consists of a block with no weld seam, machined out of high quality stainless steel. The Tank Bottom Valve has two welding levels to ease the welding and valve positioning operations.

The high quality diaphragms separate hermetically critical fluids from the actuator. The pneumatic actuator can be controlled by pneumatic pilot valves (single pilot valves, valve islands and control heads). Control function A, normally closed by spring return.

Technical data		
<b>Orifice</b>	DN 8 to 50	
<b>Body material</b>	<ul style="list-style-type: none"> <li>▪ Stainless steel 1.4435 / 316 L</li> <li>▪ Stainless steel 1.4435BN2 / ASME BPE</li> </ul> Fe < 0.5% / C ≤ 0.03%	
<b>Diaphragm materials</b>	EPDM (AB), PTFE/EPDM (EA) EPDM (AD), advanced PTFE/EPDM (EU) and FKM (FF) on request	
<b>Actuator material</b>	Actuator Cover	PPS Stainless steel 1.4561 (316Ti)
<b>Pilot air ports</b>	Stainless steel 1.4305	
<b>Surface finish</b>	Ra [µm] internal	Ra [µlnch] internal
mechanical polished	≤0,5	≤25
electro polished	≤0,38	≤15
<b>Media temperature</b>	EPDM (AB), PTFE/EPDM (EA) -10 to +130 °C (steam sterilisation +140 °C for 60 min) EPDM (AD), advanced PTFE/EPDM (EU) -5 to +143 °C (steam sterilisation +150 °C for 60 min) FKM (FF) 0 to +130 °C (not recommended for steam)	
<b>Ambient temperature</b>	+5 to +60 °C	
<b>Control medium</b>	Neutral gases, air	
<b>Max. pilot pressure</b>	max. 10 bar; Actuator size 130 mm 7 bar	

## Technical data, *continued*

<b>Port connections</b>	
Weld end	<ul style="list-style-type: none"> <li>• DIN EN ISO 1127 / ISO 4200 / DIN 11866 Series B</li> <li>• DIN 11850 Series 2 / DIN 11866 Series A</li> </ul>
Clamp	<ul style="list-style-type: none"> <li>• ASME BPE / DIN 11866 Series C</li> <li>• DIN 32676 Series A (DIN tube)</li> <li>• DIN 32676 Series B (ISO tube)</li> <li>• ASME BPE</li> </ul>
<b>Installation for self-draining</b>	Inclined 3 to 5° downwards

<sup>1)</sup> Advanced PTFE/EPDM is recommended for sterilization cycle

## Technical data valves

### Kv-values

Port size		Kv value water (m <sup>3</sup> /h)	Actuator size Ø [mm]	Permitted pilot pressure [bar]		Max. operating pressure [bar] for seal material	
[mm]	[inch]			min.	max.	EPDM, FKM [bar]	PTFE/EPDM, advanced PTFE/ EPDM [bar]
8	1/4"	1.0	50	5	10	10	10
10	3/8"	1.0	50	5	10	10	10
15	1/2"	5.5	70	5	10	10	10
20	3/4"	10.0	70	5	10	10	10
25	1"	14.0	70	5	10	6.5	6
			90	5.5	10	10	8
40	1 1/2"	30.0	130	5.0	7	10	10
50	2"	51.5	130	5.0	7	8	7

#### Flow rate: Kv-value water (m<sup>3</sup>/h)

Measured at +20 °C, 1 bar pressure at valve inlet and free outlet.

#### Pressure values (bar)

Measured as overpressure to the atmospheric pressure.

## Approvals/certifications

### Suitability for foodstuffs / sterile applications



- The composition of the EPDM (AB), EPDM (AD), PTFE/EPDM (EA) and advanced PTFE (EU) diaphragms corresponds to the Code of Federal Regulations, published by the FDA (Food and Drug Administration, USA).



- The composition of the EPDM (AB), EPDM (AD), PTFE/EPDM (EA) and advanced PTFE (EU) diaphragms is suitable for the application with food and beverage (acc. to EC-Regulation 1935/2004/EC)

- The composition of the EPDM (AB), EPDM (AD), PTFE/EPDM (EA) und advanced PTFE (EU) diaphragms are approved acc. USP Class VI

- Approval according to TA-air (Port size DN4-50)



- The Diaphragm valve according to 3-A approved on request (3-A Sanitary Standards Symbol Administrative Council)

## Materials

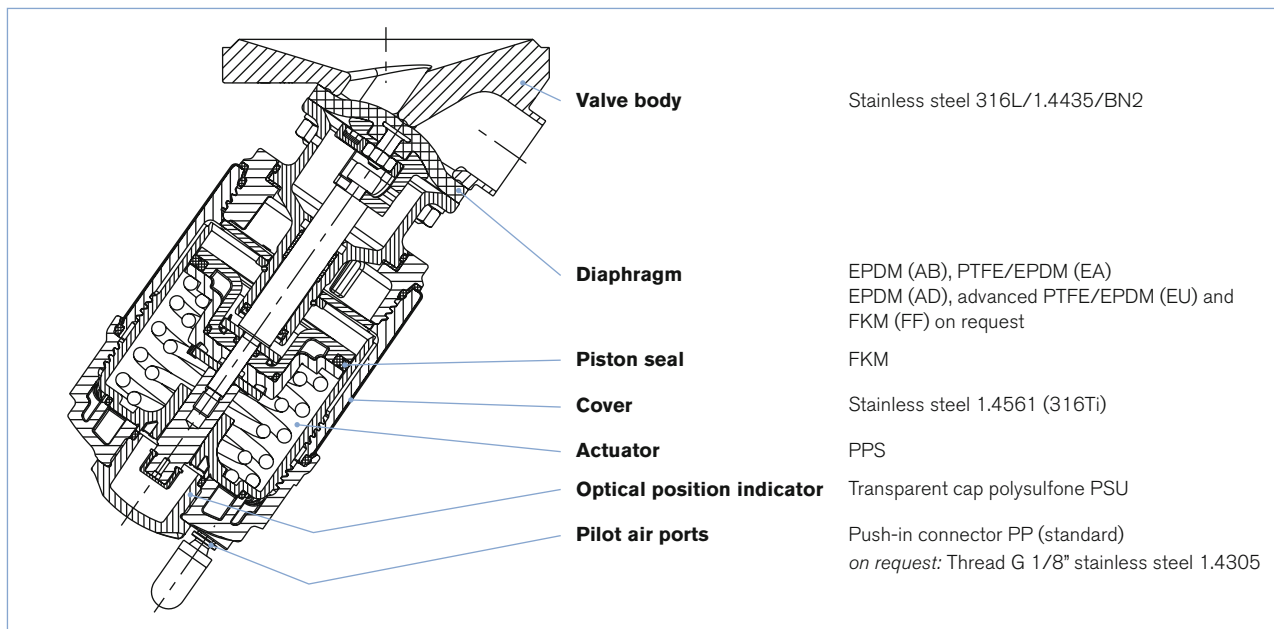

## Example of available diaphragm materials

Developed to handle the unique challenges of hygienic and sterile applications, Bürkert offers diaphragms with precise material formula and physical tolerances. Bürkert diaphragms are available in a wide range of materials which have been proven in food & beverage, biotechnology, pharmaceutical and cosmetic industry applications. Bürkert diaphragms are available in a wide range of materials which have been proven in food & beverage, biotechnology, pharmaceutical and cosmetic industry applications. Diaphragms are tested during development and production to ensure reliability in critical processing environments.



- EPDM (AB)
- EPDM (AD)
- PTFE/EPDM (EA)
- advanced PTFE/EPDM (EU)
- FKM (FF)

## Dimensions [mm]

Welded body acc. to DIN EN ISO 1127 / ISO 4200 / DIN 11866 Series B and ASME BPE

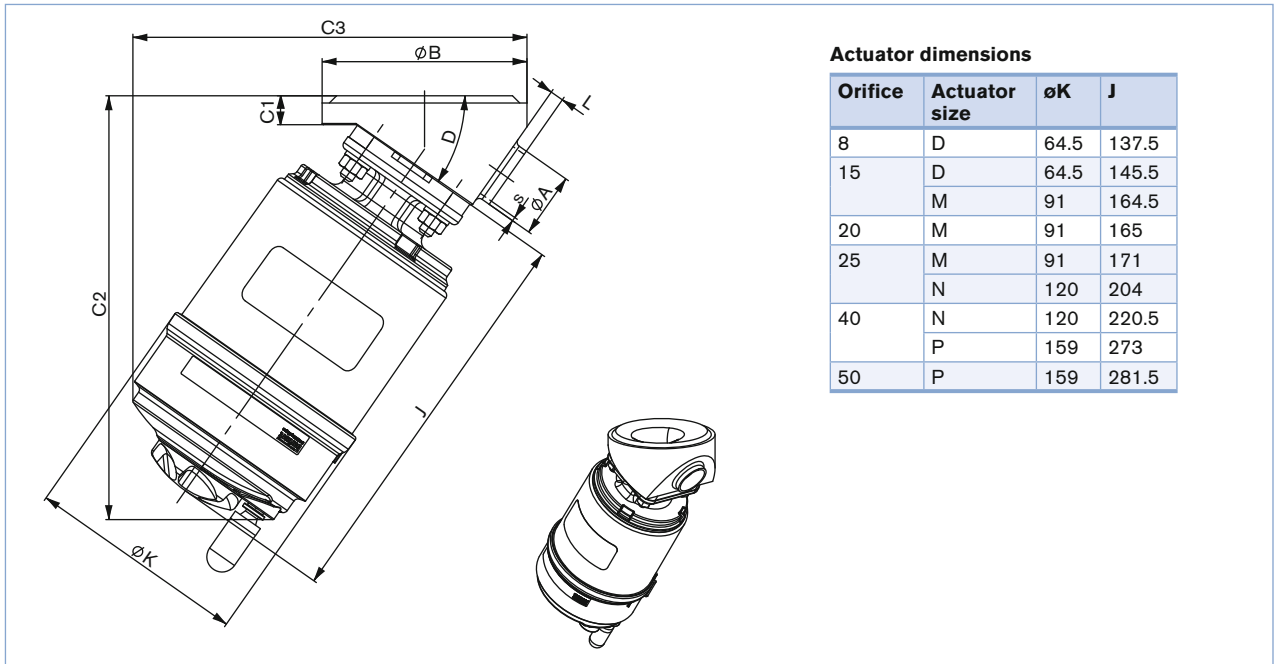

## ISO Version

DN-Seat	DN-Orifice	Actuator size	øA ±0.1	s ±0.1	øB ±2	C1	C2 ±2	C3 ±2	D	L
08	08	D	13.5	1.6	50	8	139	121	35°	5
15	15	D	21.3	1.6	65	12	152	137.5	35°	3
		M			85			172.5		156
20	20	M	26.9	1.6	85	12	176	163.5	35°	5.6
25	25	M	33.7	2	120	16	187.5	177	35°	8
		N						215		
40	32	N	42.4	2	150	18	239	241	35°	20
	40		48.3	2				15		
40	32	P	42.4	2	150	18	287.5	287.5	35°	20
	40		48.3	2						15
50	50	P	60.3	2	180	22	302.5	302	35°	12

## ASME Version

DN-Seat	DN-Orifice	Actuator size	øA ±0.1	s ±0.1	øB ±2	C1	C2 ±2	C3 ±2	D	L
08	08	D	6.35	0.89	50	8	139	121	35°	9
15	15	D	12.7	1.65	85	12	152	137.5	35°	10
		M						172.5		
20	20	M	19.05	1.65	85	12	176	163.5	35°	8
25	25	M	25.4	1.65	120	16	187.5	177	35°	8
		N						215		
40	40	N	38.1	1.65	150	18	239	241	35°	15
		P						287.5		
50	50	P	50.8	1.65	180	22	302.5	302	35°	15

Dimensions [mm], *continued*

Welded body acc. to DIN 11850 Series 2 / DIN 11866 Series A and SMS 3008

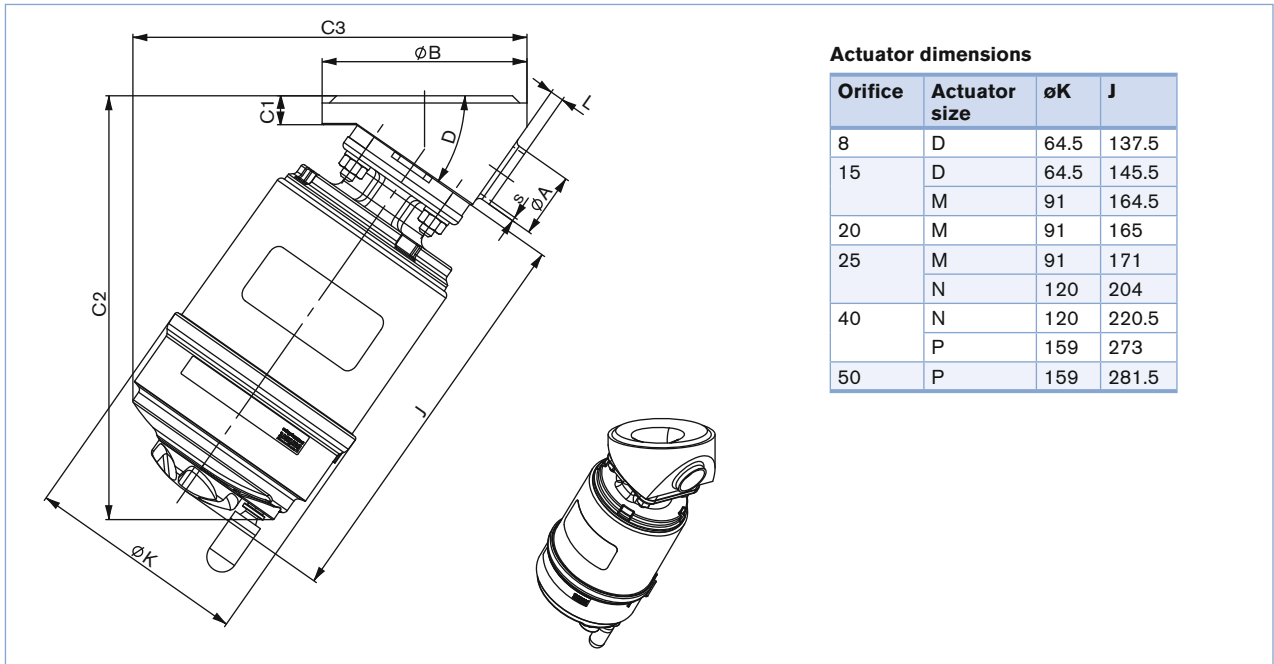

Actuator dimensions

Orifice	Actuator size	øK	J
8	D	64.5	137.5
15	D	64.5	145.5
	M	91	164.5
20	M	91	165
25	M	91	171
	N	120	204
40	N	120	220.5
	P	159	273
50	P	159	281.5

## DIN / S.2 Version

DN-Seat	DN-Orifice	Actuator size	øA ±0.1	s ±0.1	øB ±2	C1	C2 ±2	C3 ±2	D	L
08	08	D	13	1.5	50	8	139	121	35°	6
15	15	D	19	1.5	85	12	152	137.5	35°	8
		M					172.5	156		
20	20	M	23	1.5	85	12	176	163.5	35°	7
25	25	M	29	1.5	120	16	187.5	177	35°	8
		N					215	201		
40	40	N	41	1.5	150	18	239	241	35°	20
		P					287.5	287.5		
50	50	P	53	1.5	180	22	302.5	302	35°	15

## SMS Version

DN-Seat	DN-Orifice	Actuator size	øA ±0.1	s ±0.1	øB ±2	C1	C2 ±2	C3 ±2	D	L
25	25	M	25	1.2	120	16	187.5	177	35°	8
		N					215	201		
50	50	P	51	1.2	180	22	302.5	302	35°	15

Dimensions [mm], *continued*

## Clamp body

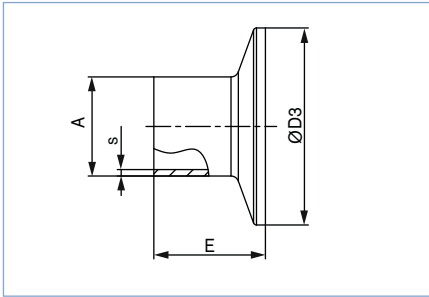

## ASME BPE

Orifice [mm]	Orifice [inch]	A	s	D3	E
08	1/4"	6.35	0.89	25.0	28.6
10	3/8"	9.53	0.89	25.0	28.6
15	1/2"	12.7	1.65	25.0	28.6
20	3/4"	19.05	1.65	25.0	28.6
25	1"	25.4	1.65	50.5	28.6
40	1 1/2"	38.1	1.65	50.5	28.6
50	2"	50.8	1.65	64.0	28.6

## DIN 32676 Series A (DIN tube)

Orifice [mm]	A	s	D3	E
10	18	1.5	34.0	18
15	19	1.5	34.0	18
20	23	1.5	34.0	18
25	29	1.5	50.5	21.5
32	35	1.5	50.5	21.5
40	41	1.5	50.5	21.5
50	53	1.5	64.0	21.5

## DIN 32676 Series B (ISO tube)

Orifice [mm]	A	s	D3	E
8	13.5	1.6	25.0	28.6
8	13.5	1.6	34.0	28.6
10	17.2	1.6	34.0	28.6
15	21.3	1.6	34.0	28.6
15	21.3	1.6	50.5	28.6
20	26.9	1.6	50.5	28.6
25	33.7	2	50.5	28.6
32	42.4	2	50.5	28.6
40	48.3	2	64.0	28.6
50	60.3	2	77.5	28.6

## SMS 3017

Orifice [mm]	A	s	D3	E
25	25	1.2	50.5	21.5
40	38	1.2	50.5	28.6
50	51	1.2	64.0	28.6

**Ordering information for valve system On/Off ELEMENT Typ 8801-TC**

A **valve system On/Off ELEMENT Type 8801-TB** consists of a **T-valve Type 2105** and a valve actuation system control head **Type 8691/8695** or a pneumatic control unit **Type 8690/8697** (see separate datasheets).

For the configuration of further valve systems please use the "Request for quotation" on p. 9-11. [go to page](#)

You order two components and receive a complete assembled and certified valve.

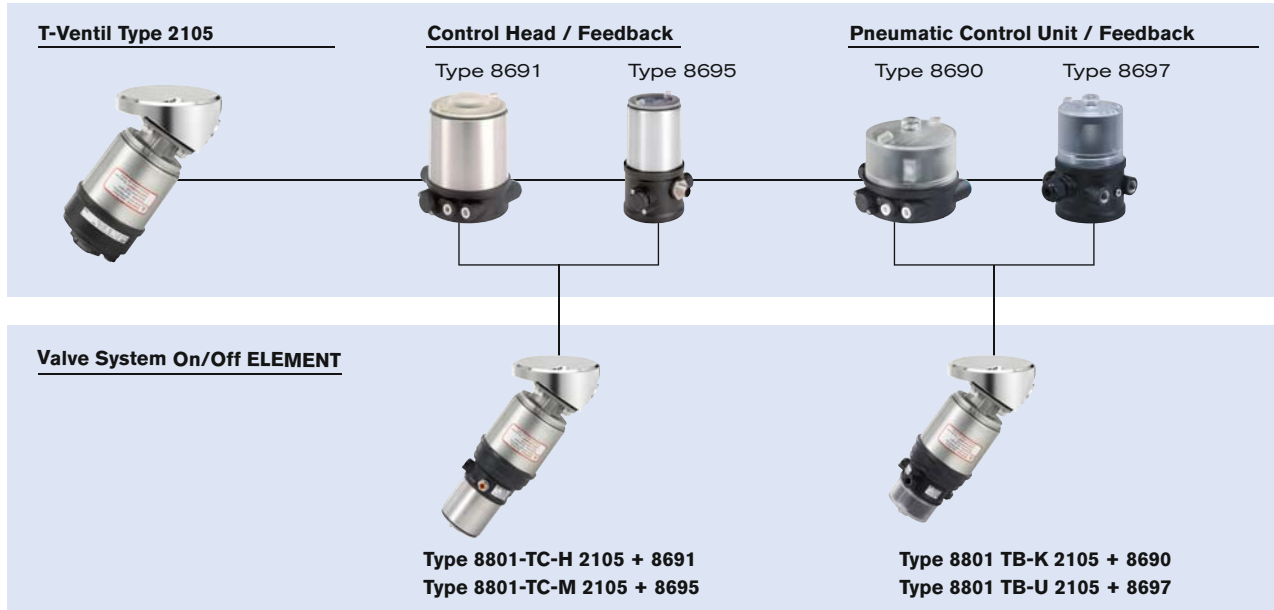

**Control Head / Feedback**



**Type 8691**  
Actuator size 70/90/130

[More info.](#)



**Type 8695**  
Actuator size 50

[More info.](#)

The Control Head Type 8691/ 8695 is optimised for integrated mounting on the 21XX process valve series. The registration of the valve end position is done through a contactless analog position sensor, which automatically recognises and saves the valve end position through the Teach function when starting up. The integrated pilot valve controls single or double-acting actuators. The status of the valve is shown through high power coloured LEDs.

- Features**
- High power coloured Status-LEDs
  - Contactless inductive position sensor
  - Pilot valve with manual override
  - Teach function for automatic registration of valve positions
  - Hygienic stainless steel design
  - Easy to clean chemically resistant housing featuring IP65 / IP67, 4X Rating
  - AS-Interface or DeviceNet Fieldbus communication

- Benefits**
- Easy and safe Start-up through Teach function
  - Easy process monitoring and error detection through clearly visible high-power coloured LEDs
  - High plant availability due to prolonged actuator life boosted by spring chamber ventilation
  - Minimised space requirement in the plant piping for more flexibility in plant design

**Pneumatic Control Unit / Feedback**



**Type 8690**  
Actuator size 70/90/130

[More info.](#)



**Type 8697**  
Actuator size 50

[More info.](#)

The pneumatic control unit Type 8697/8690 is optimised for integrated mounting on the 21XX process valve series. Mechanical or inductive limit switches register the position of the valve. The integrated pilot valve controls single or double-acting (8690) actuators.

- Features**
- Visual position indicator
  - Mechanical or inductive limit switches for end position registering
  - Pilot valve with manual override
  - Compact design
  - Easy to clean chemically resistant housing featuring IP65 / IP67, 4X Rating
  - Optional intrinsically safe version acc. to ATEX

- Benefits**
- Easy and safe Start-up through Teach function (Type 8697)
  - High level of signal reliability thanks to self adjusting limit switches
  - Minimised space requirement in the plant piping for more flexibility in plant design

Click on the orange box "More info"... you will come to our website for the resp. product where you can download the data sheet.



Dimensions Valve system On/Off ELEMENT Type 8801-TC [mm]

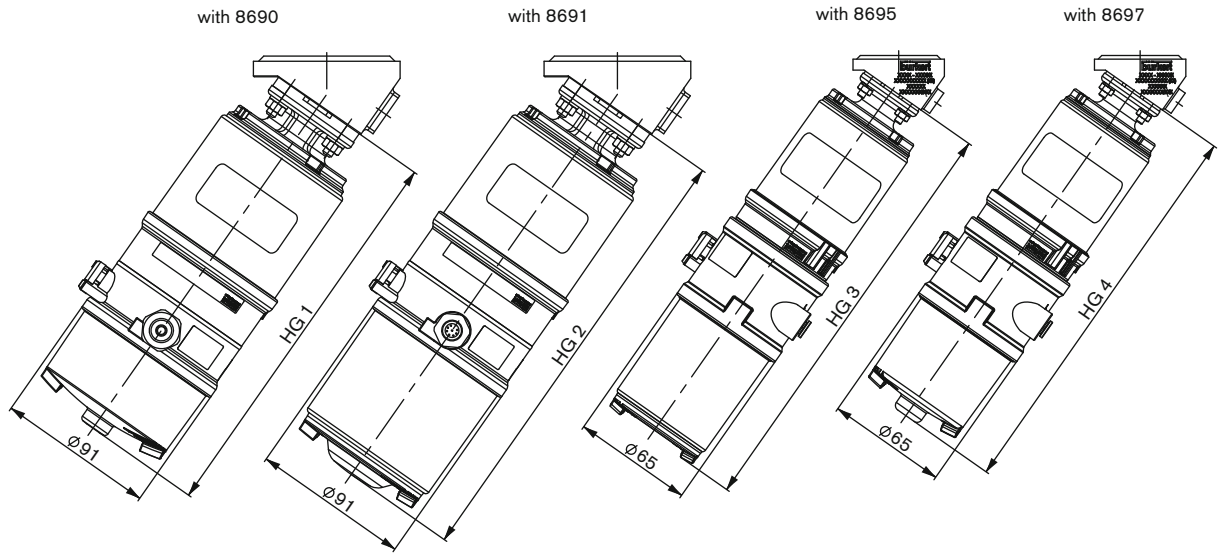

Nominal seat [mm]	Actuator size [mm]	HG 1 [mm]
15	70	227.5
20	70	228
25	70	234
	90	267
40	90	283.5
	130	336
50	130	344.5

Nominal seat [mm]	Actuator size [mm]	HG 2 [mm]
15	70	260.5
20	70	261
25	70	267
	90	300
40	90	316.5
	130	369
50	130	377.5

Nominal seat [mm]	Actuator size [mm]	HG 3 [mm]
8	50	231
15	50	239

Nominal seat [mm]	Actuator size [mm]	HG 4 [mm]
8	50	217.5
15	50	225.5

**Note**

You can fill out the fields directly in the PDF file before printing out the form.

**Valve system On/Off Element Type 8801-TC – Request for quotation**

▶ Please fill out and send to your nearest Bürkert facility\* with your inquiry or order

Company	Contact person
Customer No	Department
Address	Tel./Fax
Postcode/Town	E-mail

= mandatory fields to fill out

Quantity

Required delivery date

**Operating data**

<b>Pipe dimensions</b>	Main tube $\varnothing D1 \times s1$	<input type="text"/>	Outlet tube $\varnothing D2 \times s2$	<input type="text"/>
	Clamp main tube	<input type="text"/>	Clamp outlet	<input type="text"/>
<b>Pipe material</b>	<input type="text"/>			
<b>Surface finish Ra int.</b>	<input type="text"/>			
<input type="checkbox"/> <b>Process medium</b>	<input type="text"/>			
<input type="checkbox"/> <b>Type of medium</b>	<input type="checkbox"/> Liquid	<input type="checkbox"/> Steam	<input type="checkbox"/> Gas	
<input type="checkbox"/> <b>Flow rate (Q, QN, W) <sup>1)</sup></b>	nominal	unit		
<input type="checkbox"/> <b>Temperature at valve inlet T1</b>	<input type="text"/>	<input type="text"/>		
<input type="checkbox"/> <b>Absolute pressure at valve inlet P1</b>	<input type="text"/>	<input type="text"/>		
<input type="checkbox"/> <b>Absolute pressure at valve outlet P2</b>	<input type="text"/>	<input type="text"/>		
<b>Steam pressure Pv</b>	<input type="text"/>	<input type="text"/>		

<sup>1)</sup> Standard unit:  
Liquids Q = m<sup>3</sup>/h; Steam W = Kg/h; Gas QN = nm<sup>3</sup>/h

**Valve features**

**Specification key**

automatically transferred from last page

go to page

<input type="checkbox"/>	<input type="checkbox"/>	<input type="checkbox"/>	<input type="checkbox"/>	<input type="checkbox"/>	<input type="checkbox"/>	<input type="checkbox"/>
--------------------------	--------------------------	--------------------------	--------------------------	--------------------------	--------------------------	--------------------------

Continued on next page →









\*To find your nearest Bürkert facility, click on the orange box →



Valve system On/Off Element Type 8801-TC – Request for quotation, *continued*

**Automation unit features**

Click on the orange box "More info"... you will come to our website for the resp. product where you can download the data sheet.

Control Head / Feedback		Pneumatic Control Unit / Feedback	
<input type="checkbox"/> <b>Type 8691</b>  For actuator size 70/90/130 	<input type="checkbox"/> <b>Type 8695</b>  For actuator size 50 	<input type="checkbox"/> <b>Type 8690</b>  For actuator size 70/90/130 	<input type="checkbox"/> <b>Type 8697</b>  For actuator size 50 
<ul style="list-style-type: none"> <li>Inductive position sensor with automatic Teach function</li> <li>Coloured high power LEDs</li> <li>With/without pilot valve for single or double-acting actuators</li> <li>Fieldbus communication</li> <li>Hygienic stainless steel design</li> </ul>		<ul style="list-style-type: none"> <li>visual status indicator</li> <li>Micro- or proximity switches for end position feedback</li> <li>With/ without pilot valve for single or double-acting actuators</li> <li>Optional intrinsically safe version acc. to ATEX / IECEx</li> </ul>	
<b>Pneumatic function</b> <input type="checkbox"/> Single-acting <input type="checkbox"/> Double-acting <input type="checkbox"/> Without pilot valve	<b>Electrical connection</b> <input type="checkbox"/> Cable gland <input type="checkbox"/> M12 connector	<b>Pneumatic function</b> <input type="checkbox"/> Single-acting <input type="checkbox"/> Double-acting (only with 8690) <input type="checkbox"/> Without pilot valve	<b>Number of Position feedback switches</b> <input type="checkbox"/> 1x <input type="checkbox"/> 2x
<b>Communication</b> <input type="checkbox"/> AS-Interface <input type="checkbox"/> DeviceNet <input type="checkbox"/> without	<b>Approvals</b> <input type="checkbox"/> ATEX cat. 3GD, IECEx <input type="checkbox"/> without	<b>Position feedback switches</b> <input type="checkbox"/> Micro-switch 24V DC <input type="checkbox"/> Micro-switch 50 – 225 V DC/AC (only 8697) <input type="checkbox"/> Inductive switch 3-wire PNP <input type="checkbox"/> Inductive switch 2-wire NAMUR <input type="checkbox"/> Inductive switch 2-wire 24V DC <input type="checkbox"/> without	<b>Electrical connection</b> <input type="checkbox"/> Cable gland <input type="checkbox"/> M12 connector
			<b>Approvals</b> <input type="checkbox"/> ATEX cat. 3GD, IECEx <input type="checkbox"/> ATEX cat. 2DG, IECEx <input type="checkbox"/> without

**Certifications**

- Attestation of compliance with the order EN-ISO 10204 2.1 (Item-No. 440 788)
- Test report EN-ISO 10204 2.2 (Item-No. 803 722)
- Certification of Conformity for Raw Material EN-ISO 10204 3.1 (Included in delivery)
- EN161 (European Gas Device guideline)
- Certification according to FDA - USP

**Comment /sketch**

Valve features

Example

A 15 AB VH SA42 SA42 NO14

Specification key

Please make a choice

CONTROL FUNCTION

A	Normally closed by spring action
B	normally open by spring action
I	double acting

SIZE [mm] (Diaphragm)

8
15
20
25
40
50

SEAL MATERIAL

AB	EPDM in food quality
AD	EPDM
EU	Advanced PTFE
EA	PTFE/EPDM
FF	FKM

Body material

VH	1.4435/AISI 316 L
VI	1.4435 acc. to BN2/ASME

VARIABLE CODES

Surface finish external	
NO34	Ext. mechanical polished Ra=1.2 µm
Surface finish, internal	
NO14	Int. mechanical polished Ra=0.5 µm
NO17	Int. electro polished Ra=0.38 µm
Certificate	
NK52	3.1 Certificate

øD1 main tube connection

øD2 outlet tube connection



DN [mm]	EN ISO 1127/ ISO 4200 DIN 11866 S. B	SMS 3008	DIN 11850 S. 0	Port connection weld end			DIN 11850 S. 3	BS4825	ASME BPE DIN 11866 S. C
				DIN 11850 S. 1	DIN 11850 S. 2 DIN 11866 S. A				
4			SC40 - 6.0x1.0						
6	SA78 - 10.2x1.6		SC41 - 8.0x1.0					SA89 - 3.17x0.56	
8	SA40 - 13.5x1.6		SC42 - 10.0x1.0				SODB - 6.35x1.2	SA90 - 6.35x0.89	
10	SA41 - 17.2x1.6			SF40 - 12.0x1.0	SD40 - 13.0x1.5	SE40 - 14.0x2.0	SODC - 9.53x1.2	SA91 - 9.53x0.89	
15	SA42 - 21.3x1.6	SA58 - 12.0x1.0	SC43 - 18.0x1.5	SF41 - 18.0x1.0	SD42 - 19.0x1.5	SE42 - 20.0x2.0	SODD - 12.7x1.2	SA92 - 12.7x1.65	
20	SA43 - 26.9x1.6	SA59 - 18.0x1.0	SC44 - 22.0x1.5	SF42 - 22.0x1.0	SD43 - 23.0x1.5	SE43 - 24.0x2.0	SODE - 19.05x1.2	SA93 - 19.05x1.65	
25	SA44 - 33.7x2.0	SA60 - 25.0x1.2	SC45 - 28.0x1.5	SF43 - 28.0x1.0	SD44 - 29.0x1.5	SE44 - 30.0x2.0		SODF - 25.4x1.65	
32	SA45 - 42.4x2.0	SA61 - 33.7x1.2	SC46 - 34.0x1.5	SF44 - 34.0x1.0	SD45 - 35.0x1.5	SE45 - 36.0x2.0			
40	SA46 - 48.3x2.0	SA62 - 38.0x1.2	SC47 - 40.0x1.5	SF45 - 40.0x1.0	SD46 - 41.0x1.5	SE46 - 42.0x2.0		SODH - 38.1x1.65	
50	SA47 - 60.3x2.0	SA63 - 51.0x1.2	SC48 - 52.0x1.5	SF46 - 52.0x1.0	SD47 - 53.0x1.5	SE47 - 54.0x2.0		SODI - 50.8x1.65	

DN [mm]	Port connection Clamp		ASME BPE	BS 4825 (Clamp BS 4825-3, tube BS 4825-1)
	Clamp 34.0 like DIN 32676 S. B (ISO-tube (ISO4200))	DIN 32676 S. A (DIN-tube (DIN11850))		
8	TC51 - 13.5x1.6 Ci: 34.0	TD40 - 10.0x1.0 Ci: 25.0	TC40 - 13.5x1.6 Ci: 25.0	TG50 - 6.35x0.89 Ci: 25.0
10	TC41 - 17.2x1.6 Ci: 34.0	TD41 - 13.0x1.5 Ci: 34.0	TC53 - 17.2x1.6 Ci: 25.0	TG01 - 9.53x0.89 Ci: 25.0
15	TC42 - 21.3x1.6 Ci: 34.0	TD42 - 19.0x1.5 Ci: 34.0	TC52 - 21.3x1.6 Ci: 50.5	TG02 - 12.7x1.65 Ci: 25.0
20		TD43 - 23.0x1.5 Ci: 34.0	TC43 - 26.9x1.6 Ci: 50.5	TG03 - 19.05x1.65 Ci: 25.0
25		TD44 - 29.0x1.5 Ci: 50.5	TC44 - 33.7x2.0 Ci: 50.5	TG04 - 25.4x1.65 Ci: 50.5
32				
40		TD46 - 41.0x1.5 Ci: 50.5	TC46 - 48.3x2.0 Ci: 64.0	TG05 - 38.1x1.65 Ci: 50.5
50		TD47 - 53.0x1.5 Ci: 64.0	TC47 - 60.3x2.0 Ci: 77.5	TG06 - 50.8x1.65 Ci: 64.0

In case of special application conditions,  
please consult for advice.

Subject to alteration  
© Christian Bürkert GmbH & Co. KG

1508/4\_EUen\_00895245

