

По вопросам продаж и поддержки обращайтесь:

Архангельск (8182)63-90-72	Краснодар (861)203-40-90	Рязань (4912)46-61-64
Астана (7172)727-132	Красноярск (391)204-63-61	Самара (846)206-03-16
Белгород (4722)40-23-64	Курск (4712)77-13-04	Санкт-Петербург (812)309-46-40
Брянск (4832)59-03-52	Липецк (4742)52-20-81	Саратов (845)249-38-78
Владивосток (423)249-28-31	Магнитогорск (3519)55-03-13	Смоленск (4812)29-41-54
Волгоград (844)278-03-48	Москва (495)268-04-70	Сочи (862)225-72-31
Вологда (8172)26-41-59	Мурманск (8152)59-64-93	Ставрополь (8652)20-65-13
Воронеж (473)204-51-73	Набережные Челны (8552)20-53-41	Тверь (4822)63-31-35
Екатеринбург (343)384-55-89	Нижний Новгород (831)429-08-12	Томск (3822)98-41-53
Иваново (4932)77-34-06	Новокузнецк (3843)20-46-81	Тула (4872)74-02-29
Ижевск (3412)26-03-58	Новосибирск (383)227-86-73	Тюмень (3452)66-21-18
Казань (843)206-01-48	Орел (4862)44-53-42	Ульяновск (8422)24-23-59
Калининград (4012)72-03-81	Оренбург (3532)37-68-04	Уфа (347)229-48-12
Калуга (4842)92-23-67	Пенза (8412)22-31-16	Челябинск (351)202-03-61
Кемерово (3842)65-04-62	Пермь (342)205-81-47	Череповец (8202)49-02-64
Киров (8332)68-02-04	Ростов-на-Дону (863)308-18-15	Ярославль (4852)69-52-93

Единый адрес: btk@nt-rt.ru **Веб-сайт:** www.burkert.nt-rt.ru

РЕГУЛИРУЮЩИЕ КЛАПАНЫ



Pneumatically operated 2/2 way valve with separating diaphragm

- Media separated by diaphragm
- Stainless steel or brass body with threaded connection
- High service life
- Compact design

Product variants described in the data sheet may differ from the product presentation and description.

Can be combined with

	Type 6012 Plunger valve 3/2 way direct-acting	▶
	Type 6014 Plunger valve 3/2 way direct-acting	▶
	Type 8311 Pressure measuring device / Switch	▶
	Type 8640 Customized Pneumatic Systems Solutions for the Processing Industries	▶
	Type 8644 Remote Process Actuation Control System AirLINE	▶

Type description

The externally piloted 2-way valve is operated by a diaphragm actuator. A diaphragm between valve body and actuator separates the media. A double spindle seal guarantees high tightness and a high service life. The compact actuator housing is made out of chemical resistant plastic and is ideal for customer specific multifunction block solutions.

This low maintenance and robust valve can be supplemented by a large accessory program.

1. General technical data

Product properties	
Dimensions	Detailed information can be found in chapter "5. Dimensions" on page 5.
Material	
Body	Brass, stainless steel
Inner part valve	Stainless steel
Actuator	Epoxy resin
Seal	NBR, FKM, EPDM
Orifice	DN 10, DN 12
Performance data	
Pilot pressure	Detailed information can be found in chapter "6. Performance specifications" on page 6.
Medium data	
Medium	
With NBR	Neutral medium, e.g. compressed air, town gas, water, hydraulic oil
With FKM	Per-solution, oxygen, hot air
With EPDM	Oil and fat-free medium, e.g. hot water, alkaline washing and bleaching lyes
Medium temperature	
With NBR	-10 °C...+90 °C
With FKM	-10 °C...+100 °C
With EPDM	-10 °C...+100 °C
Viscosity	Max. 100 mm ² /s
Control medium	Neutral gases and liquids, in particular air, water, hydraulic liquids up to max. +90 °C
Environment and installation	
Ambient temperature	-10 °C...+90 °C
Installation position	As required, preferably with actuator upright

2. Circuit functions

Control function	Description
	CF: A, pneumatically operated on/off valve 2/2 way Flow direction below seat Normally closed by spring force
	CF: B, pneumatically operated on/off valve 2/2 way Flow direction above seat Normally opened by spring force
	CF: I, pneumatically operated on/off valve on either side 2/2 way Flow direction below seat Normally closed (without spring)

3. Approvals

Approvals	Description
	Explosion protection As category 2 device suitable for zone 1/21 and zone 2/22 (option)
	ATEX: II 2G Ex h IIC T4 Gb II 2D Ex h IIIC T135 °C Db IECEX: Ex h IIC T4 Gb Ex h IIIC T135 °C Db

4. Materials

4.1. Chemical Resistance Chart – Bürkert resistApp

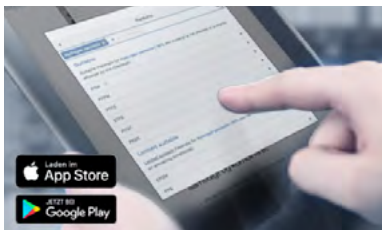

Bürkert resistApp – Chemical Resistance Chart

You want to ensure the reliability and durability of the materials in your individual application case? Verify your combination of media and materials on our website or in our resistApp.

[Start Chemical Resistance Check](#)

4.2. Material specifications

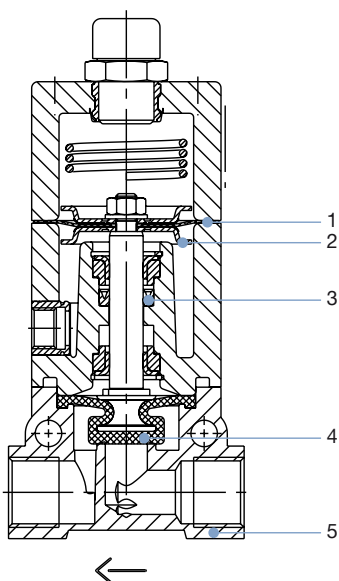

No.	Element	Material
1	Control diaphragm	FKM
2	Spring plate	Stainless steel 1.4301
3	Lip seal	NBR, EPDM, FKM
4	Diaphragm	NBR, EPDM, FKM
5	Body	Brass, stainless steel 1.4581

5. Dimensions

Note:

- Upper pilot air port only for CFB and CFI
- Dimensions in mm

DN 10/DN 12

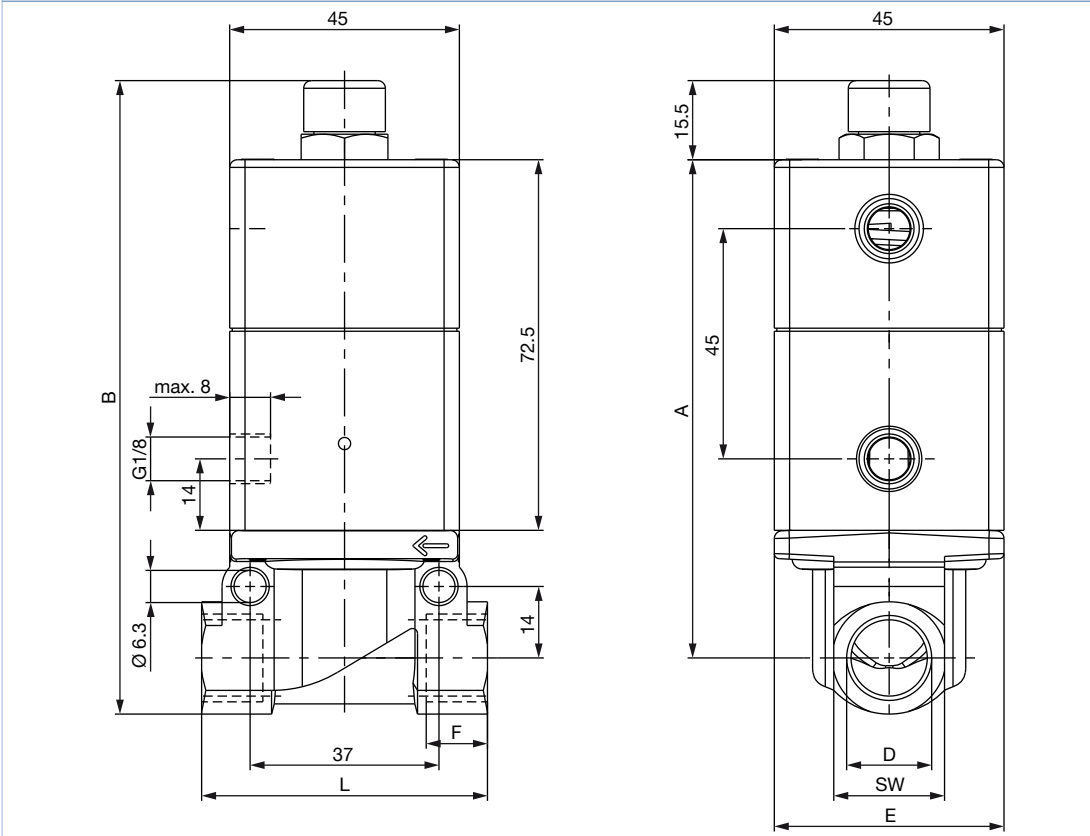

Orifice	D	A	B	E	F	L	SW
10	G 3/8	97.5	124	45	12	56	22
12	G 1/2	96.5	127.5	40	14	74.5	27

6. Performance specifications

6.1. Pressure range

Orifice	K _v value water	Port connection	Operating pressure max.			Weight
			CF: A normal spring	CF: A reinforced spring	CF: B and I normal spring	
[mm]	[m ³ /h] ^{1.)}		[bar] ^{2.)}	[bar] ^{2.)}	[bar] ^{2.)}	[kg]
10	1.0	G 3/8	2.5	5	10	0.5
12	2.1	G 1/2	2	4.5	10	0.6

1.) Flow rate K_v value water: measured at +20 °C, 1 bar pressure at valve inlet and free outlet

2.) Pressure data: Measured as overpressure to the atmospheric pressure

6.2. Operating pressure/pilot pressure diagram

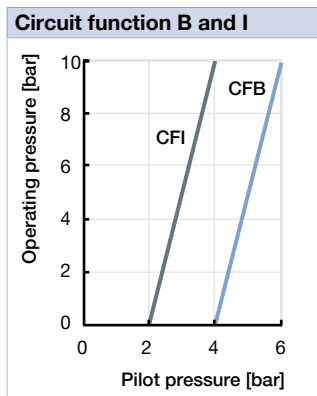

7. Ordering information

7.1. Bürkert eShop – Easy ordering and quick delivery



Bürkert eShop – Easy ordering and fast delivery

You want to find your desired Bürkert product or spare part quickly and order directly? Our online shop is available for you 24/7. Sign up and enjoy all the benefits.

[Order online now](#)

7.2. Bürkert product filter



Bürkert product filter – Get quickly to the right product























You want to select products comfortably based on your technical requirements? Use the Bürkert product filter and find suitable articles for your application quickly and easily.

[Try out our product filter](#)

7.3. Ordering chart

Note:

Valves with threaded connection

Circuit function	Orifice	Port connection	K _v value water [m ³ /h] ^{1.)}	Pressure spring actuator	Operating pressure max. [bar] ^{2.)}	Seal material	Article no.	
	[mm]							
Brass body								
A	10	G 3/8	1.0	normal	2.5	FKM	027963 	
						NBR	027342 	
				reinforced	5	EPDM	027929 	
						FKM	026903 	
						NBR	026065 	
		12	G 1/2	2.1	normal	2	EPDM	026094 
						FKM	026246 	
						NBR	026207 	
	reinforced				4.5	EPDM	028023 	
						FKM	027695 	
				NBR	027881 			
B	10	G 3/8	1.0	normal	10	EPDM	028980 	
						FKM	028037 	
						NBR	026455 	
	12	G 1/2	2.1	normal	10	EPDM	027987 	
						FKM	028827 	
						NBR	027962 	
Stainless steel body								
A	12	G 1/2	2.1	reinforced	4.5	EPDM	027428 	
						FKM	026944 	
						NBR	027328 	
B	12	G 1/2	2.1	normal	10	EPDM	289834 	
						FKM	029259 	

 1.) Flow rate K_v value water: measured at +20 °C, 1 bar pressure at valve inlet and free outlet

2.) Pressure data: Measured as overpressure to the atmospheric pressure

