

По вопросам продаж и поддержки обращайтесь:

Архангельск (8182)63-90-72	Краснодар (861)203-40-90	Рязань (4912)46-61-64
Астана (7172)727-132	Красноярск (391)204-63-61	Самара (846)206-03-16
Белгород (4722)40-23-64	Курск (4712)77-13-04	Санкт-Петербург (812)309-46-40
Брянск (4832)59-03-52	Липецк (4742)52-20-81	Саратов (845)249-38-78
Владивосток (423)249-28-31	Магнитогорск (3519)55-03-13	Смоленск (4812)29-41-54
Волгоград (844)278-03-48	Москва (495)268-04-70	Сочи (862)225-72-31
Вологда (8172)26-41-59	Мурманск (8152)59-64-93	Ставрополь (8652)20-65-13
Воронеж (473)204-51-73	Набережные Челны (8552)20-53-41	Тверь (4822)63-31-35
Екатеринбург (343)384-55-89	Нижний Новгород (831)429-08-12	Томск (3822)98-41-53
Иваново (4932)77-34-06	Новокузнецк (3843)20-46-81	Тула (4872)74-02-29
Ижевск (3412)26-03-58	Новосибирск (383)227-86-73	Тюмень (3452)66-21-18
Казань (843)206-01-48	Орел (4862)44-53-42	Ульяновск (8422)24-23-59
Калининград (4012)72-03-81	Оренбург (3532)37-68-04	Уфа (347)229-48-12
Калуга (4842)92-23-67	Пенза (8412)22-31-16	Челябинск (351)202-03-61
Кемерово (3842)65-04-62	Пермь (342)205-81-47	Череповец (8202)49-02-64
Киров (8332)68-02-04	Ростов-на-Дону (863)308-18-15	Ярославль (4852)69-52-93

Единый адрес: btk@nt-rt.ru **Веб-сайт:** www.burkert.nt-rt.ru

РАСХОДОМЕРЫ ЖИДКОСТИ И ГАЗА

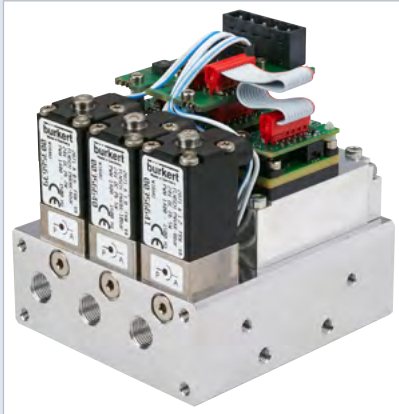

Multi-Channel Mass Flow Controller (MFC) / Meter (MFM) for Gases

- Nominal flow ranges from 0.01 I_N/min to 20 I_N/min
- High accuracy and repeatability
- Very fast response times
- Modular combination with additional modules
- Customized system without development effort



Product variants described in the data sheet may differ from the product presentation and description.

Can be combined with

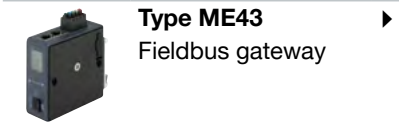

Type ME43
Fieldbus gateway

Type description

Type 8735 forms the basis of the modular and economical multi-channel flow control systems for gases. The semi-standardized modular system consists of assemblies that can be put together flexibly and according to requirements. The heart of the system are the thermal mass flow controller/ meter (MFC/ MFM) for gases. Type 8735 thus enables tailor-made solutions without generating long development times and development costs. Type 8735 multi-channel MFC/MFM systems are aimed at applications with several control loops and high volumes. For example, laboratory analysis equipment for spectroscopy or gas chromatography.

1. General Technical Data

Product properties	
Dimensions	Detailed information can be found in chapter "3. Dimensions" on page 4.
Materials	
Basic block	Aluminium
Fluidics	PPS, stainless steel
Seal	FKM
Total mass	approx. 70 g (MFM module), 3-channel MFC system (exemplary) approx. 900 g
Software tool	Bürkert Communicator Detailed information can be found in chapter "6.1. Bürkert Communicator Software" on page 7.
Performance data	
Nominal flow range (Q_{nominal})	0.05...20 l_N/min (N_2)
Measuring range	1:50
Measuring accuracy	$\pm 1.5\%$ o.R. ¹⁾ $\pm 0.3\%$ F.S. ²⁾ (after 15 min warm-up time)
Repeatability	$\pm 0.15\%$ F.S. ²⁾
Response time ($t_{95\%}$)	< 700 ms (without output filter < 100 ms)
Operating pressure (max.)	6 bar (90 PSI)
Actuator (proportional valve)	Type 2871 (normally closed)
Electrical data	
Operating voltage	3.3 V DC ± 0.1 V (MFM module with I ² C) or 24 V DC $\pm 10\%$ (system with standardized electronics for b \ddot{u} S, CANopen or I ² C)
Power consumption (max.)	0.3 W (MFM module); for MFC systems depending on the number of control loops and power consumption of the valves
Residual ripple	$\pm 2\%$
Electrical connection	MicroMatch®, 10 pin (I ² C), terminal strip, 5 pin (b \ddot{u} S, CANopen), others on request
Medium data	
Operating medium	Air, O ₂ , N ₂ , Ar, CH ₄ (up to 20 l_N/min) H ₂ , He (up to 70 l_N/min) CO ₂ (up to 10 l_N/min) C ₃ H ₈ (up to 6 l_N/min)
Calibration medium	Operating gas or air (for O ₂ , N ₂)
Gas temperature	0 °C to +50 °C
Process/Port connection & communication	
Port connection	Sub-base (pure MFM module), threaded connections, or any other port connections possible on request
Digital communication	I ² C, CANopen or CANopen-based b \ddot{u} S (enables flexible combination with Bürkert Fieldbus Gateways)
Environment and installation	
Installation position	Horizontal or vertical
Ambient temperature	0 °C to +50 °C (MFM module)
Degree of protection	IP00

1.) o.R. = of reading

2.) F.S. = full scale

2. Approvals

Note:

- The approvals and conformities listed below must be stated when making enquiries. This is the only way to ensure that the product complies with all required specifications.
- Not all available types can be supplied with the approvals or conformities below.

Approvals	Description
	Conformity of all materials in contact with the medium USP Class VI chapter “87 in vitro” and „88 in vivo, Implantation“
	Conformity of all materials in contact with the medium FDA – Code of Federal Regulations Title 21 Paragraph 177 (CFR 21 177.2600)

3. Dimensions

3.1. MFM module

Note:

Dimensions in mm

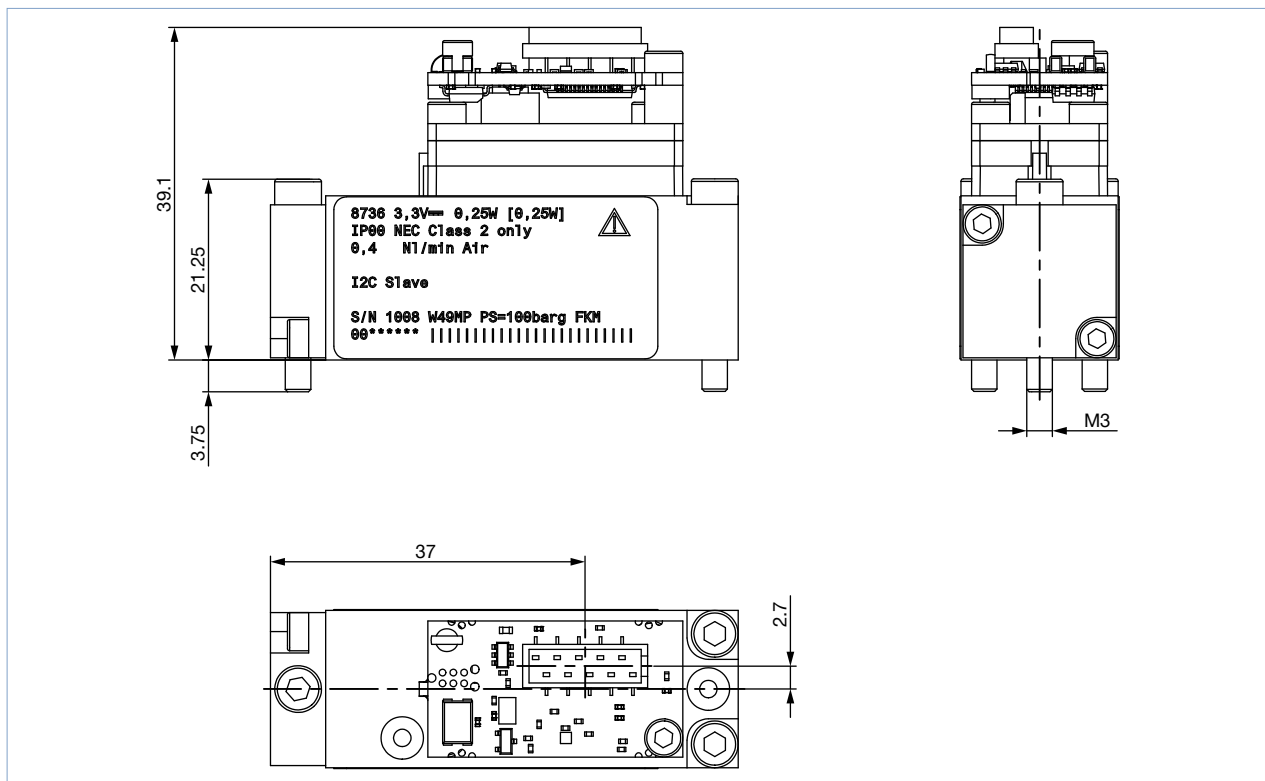

3.2. 3-channel control system

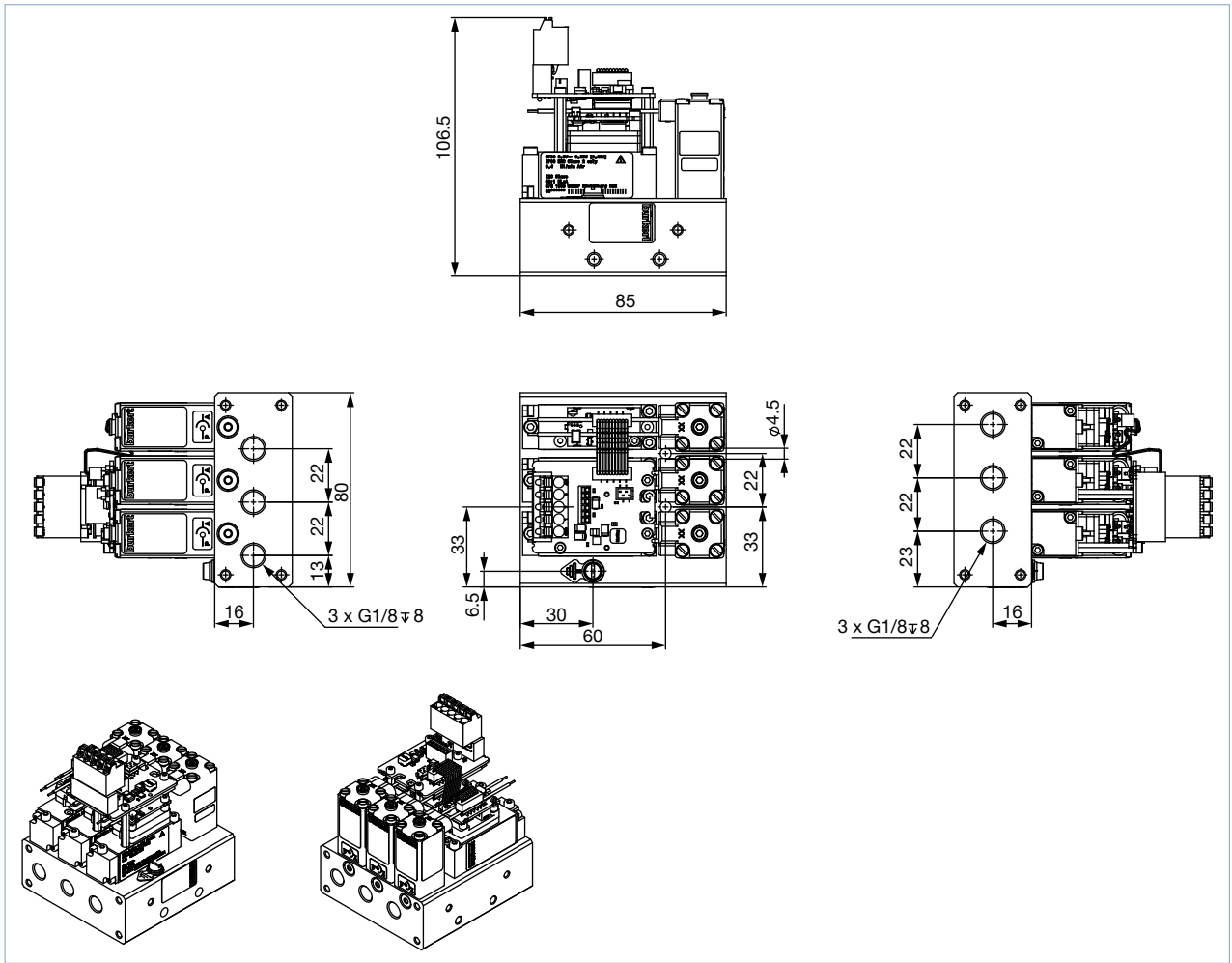

4. Device/Process connections

4.1. Electrical connections

I²C Interface

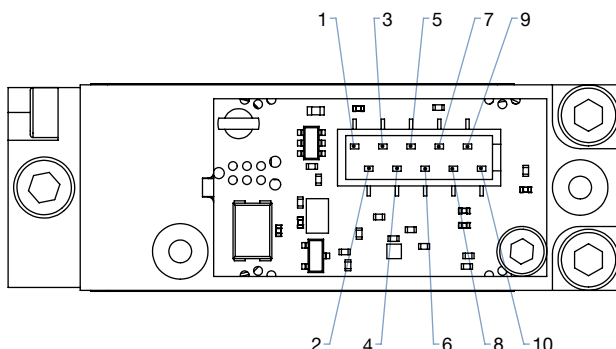

Pin	Configuration
1	Internal use
2	Internal use
3	Internal use
4	Internal use
5	Not used
6	Not used
7	I ² C SDA
8	VDD 3.3 V
9	GND
10	I ² C SCL

büS / CANopen Interface

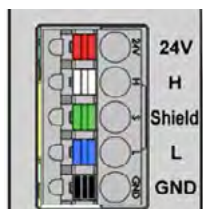

Colour	Configuration
Red	24 V DC
White	CAN H
Green	Shield
Blue	CAN L
Black	GND

5. Product operation

5.1. Measuring principle

The flow measurement takes place directly in the bypass channel.

A laminar flow element in the main channel generates a small pressure drop, which drives a small part of the total flow through the bypass channel. The sensor is located there and measures the mass flow directly as a temperature difference. The measurement is performed in a specially shaped flow channel, the wall of which contains a Si chip with an etched membrane at one point. A heating resistor and, symmetrically to this, two temperature sensors, one upstream and one downstream, are placed on this membrane.

If the heating resistor is fed with a constant voltage, the differential voltage of the temperature sensors is a measure for the mass flow of the gas flowing over the chip in the flow channel.

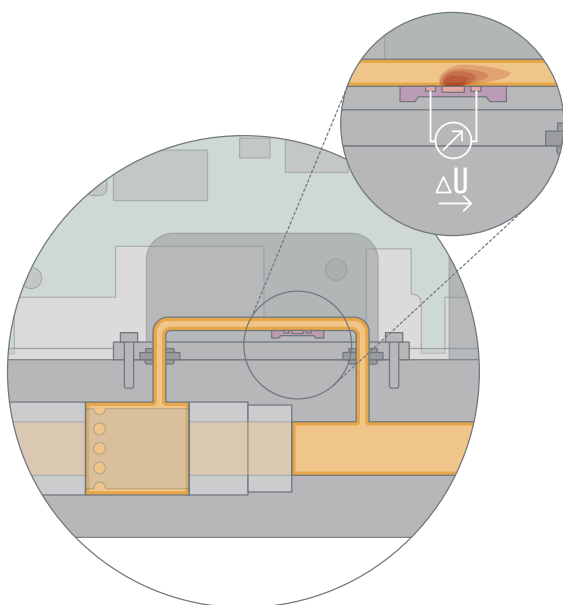

6. Product accessories

6.1. Bürkert Communicator Software

Note:

To install the software, click [here](#) ▶.

Part of Bürkert's new EDIP program (Efficient Device Integration Platform) is the Bürkert Communicator. This software can be run under MS-Windows and it is available on Bürkert's website for free. The Bürkert Communicator allows convenient system configuration and parametrisation of all connected field devices. An accessory part, the büS stick serves as the interface between computer and process instruments. The Communicator allows:

- Diagnostics
- Parametrization
- Registration and storage of process data
- Graphical monitoring of the process data
- To update firmware of the büS device connected
- Guided re-calibration

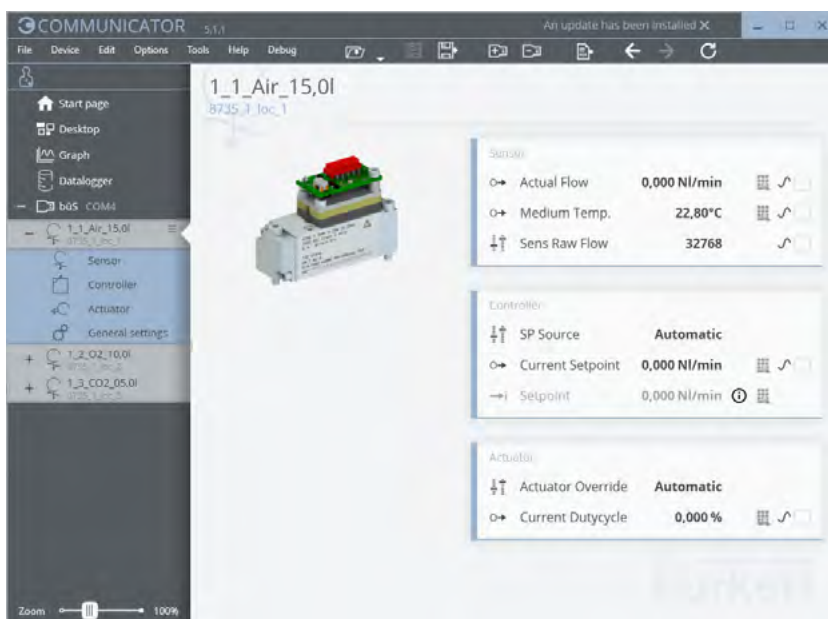

6.2. Expansion programme

Standardized modular system

If you need a customized and at the same time timely solution for your fluidic challenge, the standardized modular system is the ideal solution. No development costs whatsoever arise for you.

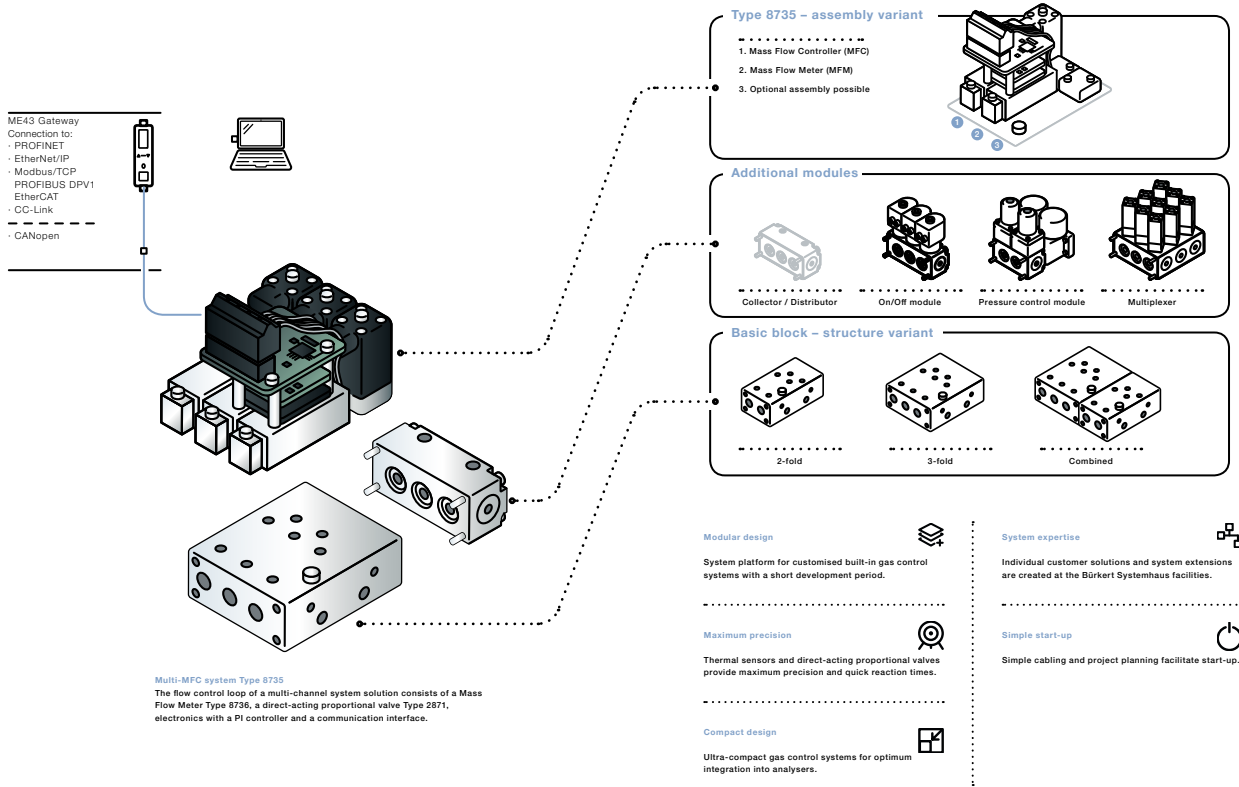

Highly integrated system solution

If your requirements go beyond the scope of the standardized modular system, we offer you the possibility of a highly integrated system solution, including hardware and software development.

