

По вопросам продаж и поддержки обращайтесь:

Архангельск (8182)63-90-72	Краснодар (861)203-40-90	Рязань (4912)46-61-64
Астана (7172)727-132	Красноярск (391)204-63-61	Самара (846)206-03-16
Белгород (4722)40-23-64	Курск (4712)77-13-04	Санкт-Петербург (812)309-46-40
Брянск (4832)59-03-52	Липецк (4742)52-20-81	Саратов (845)249-38-78
Владивосток (423)249-28-31	Магнитогорск (3519)55-03-13	Смоленск (4812)29-41-54
Волгоград (844)278-03-48	Москва (495)268-04-70	Сочи (862)225-72-31
Вологда (8172)26-41-59	Мурманск (8152)59-64-93	Ставрополь (8652)20-65-13
Воронеж (473)204-51-73	Набережные Челны (8552)20-53-41	Тверь (4822)63-31-35
Екатеринбург (343)384-55-89	Нижний Новгород (831)429-08-12	Томск (3822)98-41-53
Иваново (4932)77-34-06	Новокузнецк (3843)20-46-81	Тула (4872)74-02-29
Ижевск (3412)26-03-58	Новосибирск (383)227-86-73	Тюмень (3452)66-21-18
Казань (843)206-01-48	Орел (4862)44-53-42	Ульяновск (8422)24-23-59
Калининград (4012)72-03-81	Оренбург (3532)37-68-04	Уфа (347)229-48-12
Калуга (4842)92-23-67	Пенза (8412)22-31-16	Челябинск (351)202-03-61
Кемерово (3842)65-04-62	Пермь (342)205-81-47	Череповец (8202)49-02-64
Киров (8332)68-02-04	Ростов-на-Дону (863)308-18-15	Ярославль (4852)69-52-93

Единый адрес: btk@nt-rt.ru **Веб-сайт:** www.burkert.nt-rt.ru

**ШАРОВЫЕ КРАНЫ,
ЗАТВОРЫ ДИСКОВЫЕ**



Ball valve / Butterfly valve with pneumatic rotary actuator

- Pneumatic rotary actuator
- Accurate end position setting
- High flow values
- High medium pressures
- Long lifetime



Product variants described in the data sheet may differ from the product presentation and description.

Can be combined with

	Type 6519 ▶ Servo-assisted 5/2, 5/3 or 3/2 way Solenoid Valve for pneumatics
	Type 1061 ▶ Accessory for pneumatic rotary actuators
	Type 8791 ▶ Digital electropneumatic Positioner SideControl
	Type 8792 ▶ Digital electropneumatic Positioner SideControl
	Type 8793 ▶ Digital electropneumatic Process Controller SideControl
	Type 8691 ▶ Control head for decentralised automation of ELEMENT process valves
	Type 8692 ▶ Digital electropneumatic Positioner for the integrated mounting on process control valves

Type description

Type 8805 consists of a quarter turn valve (ball or butterfly valve) and a pneumatic rotary actuator. The rotary actuator is available as single or double-acting actuator. Type 8805 can be complemented by a positioner (8791, 8792, 8793, 8691, 8692, 8693, 8694), a pilot valve (6519) or several kinds of position feedbacks (1061).

1. General Technical Data

Product properties	
Dimensions	Detailed information can be found in chapter "4. Dimensions" on page 6.
Material	
Body	Stainless steel 1.4408
Seal	Ball seal: PTFE Selector shaft seal: FKM
Actuator	Aluminium
Ball	Stainless steel 1.4401
Switch position	Stainless steel 1.4401
Nominal diameter/Orifice	2/2 way ball valve: 10...100 mm 3/2 way ball valve: 10...40 mm
Performance data	
Pressure range	Detailed information can be found in chapter "6. Ordering information" on page 11.
Pilot pressure (max.)	6...8 bar ^{1.)}
Medium data	
Medium	Aggressive media which are compatible with the body and sealing materials.
Medium temperature	Depending on the ball valve model used and the medium pressure, see "5.1. Pressure temperature diagram" on page 11. The temperature limits of the actuators are usually lower. Accordingly, for systems consisting of ball valve and actuator, it must be ensured that the temperature limits of the other system components (e.g. the actuators) are not exceeded due to possible heat radiation from the medium.
Control medium	Compressed air, filtered, dry or oiled
Process/Port connection & communication	
Port connection	2/2 way ball valve: Rp 1/4" - Rp 4" Whitworth Thread acc. DIN EN 10226-1 (old DIN 2999) Weld end Flange 3/2 way ball valve: Rp 1/4" - Rp 2" Whitworth Thread acc. DIN EN 10226-1 (old DIN 2999)
Environment and installation	
Ambient temperature	-10 °C...+80 °C, see "5.1. Pressure temperature diagram" on page 11.
Installation position	As required, preferably with actuator upright

1.) Pressure values [bar]: Measured as overpressure with respect to the atmospheric pressure; Selection of units for smaller control pressures on request.

1.1. 2/2 way ball valve, stainless steel body

Note:

For more information about the control function, see "2. Circuit functions" on page 4.

Nominal diameter/ Orifice DN	Control function ^{1.)}	K _v value water VA 2-/3-pieces/compact flange ball valve	Nominal pressure ^{2.)}			Weight		
			VA 2 pieces	VA 3 pieces	VA compact flange ball valve	VA 2 pieces	VA 3 pieces	VA compact flange ball valve
[mm]		[m ³ /h]	[bar]	[bar]	[bar]	[kg]	[kg]	[kg]
10 / 12	A, B	9/13	100	63	–	1.5	1.85	–
	I	9/13	100	63	–	1.4	1.75	–
15	A, B	19	100	63	–	2.2	2.45	–
	I	19	100	63	–	1.5	1.75	–
20	A, B	46	100	63	40	4.0	2.7	3.8
	I	46	100	63	40	2.4	1.95	2.1
25	A, B	72	100	63	40	4.3	4.6	6.0
	I	72	100	63	40	2.6	2.3	4.4
32	A, B	105	100	63	40	5.9	5.25	7.7
	I	105	100	63	40	4.2	3.6	6.2
40	A, B	170	100	63	40	7.6	7.4	9.8
	I	170	100	63	40	5.9	4.6	8.1
50	A, B	275	100	63	40	13.4	9.1	12.8
	I	275	100	63	40	7.4	7.4	9.0
65	A, B	507	100	63	16	–	16.0	20
	I	507	100	63	16	–	13.2	14

Nominal diameter/ Orifice DN	Control function ^{1.)}	K _v value water VA 2-/3-pieces/compact flange ball valve	Nominal pressure ^{2.)}			Weight		
			VA 2 pieces	VA 3 pieces	VA compact flange ball valve	VA 2 pieces	VA 3 pieces	VA compact flange ball valve
[mm]		[m ³ /h]	[bar]	[bar]	[bar]	[kg]	[kg]	[kg]
80	A, B	905	100	63	16	–	25.1	26.3
	I	905	100	63	16	–	19.6	17.3
100	A, B	1414	100	63	16	–	35.2	29
	I	1414	100	63	16	–	28	21.8

1.) Control function A, B are single-acting, I is double-acting

2.) Operating pressure: See "5.1. Pressure temperature diagram" on page 11.

1.2. 3/2 way ball valve, stainless steel body

Nominal diameter/ Orifice DN	Port connection	K _v value water	Nominal pressure ^{1.)}	Weight SFA	Weight SFI
[mm]	[inch]	[m ³ /h]	[bar]	[kg]	[kg]
10/12	¼ / ⅜	4.7 / 6.9 ^{1.)}	63	2.55	–
				–	1.85
12	½	6.9 / 11.2 ^{1.)}	63	2.7	–
				–	2.0
15	¾	6.9 / 11.2 ^{1.)}	63	4.3	–
				–	2.2
20	1	18.9 / 29.2 ^{1.)}	63	4.9	–
				–	3.4
25	1¼	35.3 / 46.4	63	7.3	–
				–	5.75
32	1½	46.4 / 72.2 ^{1.)}	63	8.3	–
				–	6.7
40	2	83.4 / 135.9 ^{1.)}	63	13.9	–
				–	11.5

1.) Depending on the switch position

2. Circuit functions

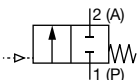
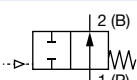
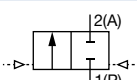
Control function	Description
	CF: A, pneumatically operated on/off valve 2/2 way Flow direction above seat Normally closed by spring force
	CF: B, single-acting actuator for pneumatically operated on/off valve 2/2 way Normally opened by spring force
	CF: I, pneumatically operated on/off valve on either side 2/2 way Flow direction above seat Normally closed (without spring)

3. Materials

3.1. Chemical Resistance Chart – Bürkert resistApp

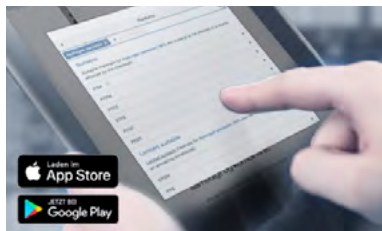

Bürkert resistApp – Chemical Resistance Chart

You want to ensure the reliability and durability of the materials in your individual application case? Verify your combination of media and materials on our website or in our resistApp.

[Start Chemical Resistance Check](#)

4. Dimensions

4.1. 2/2 way ball valve, stainless steel body

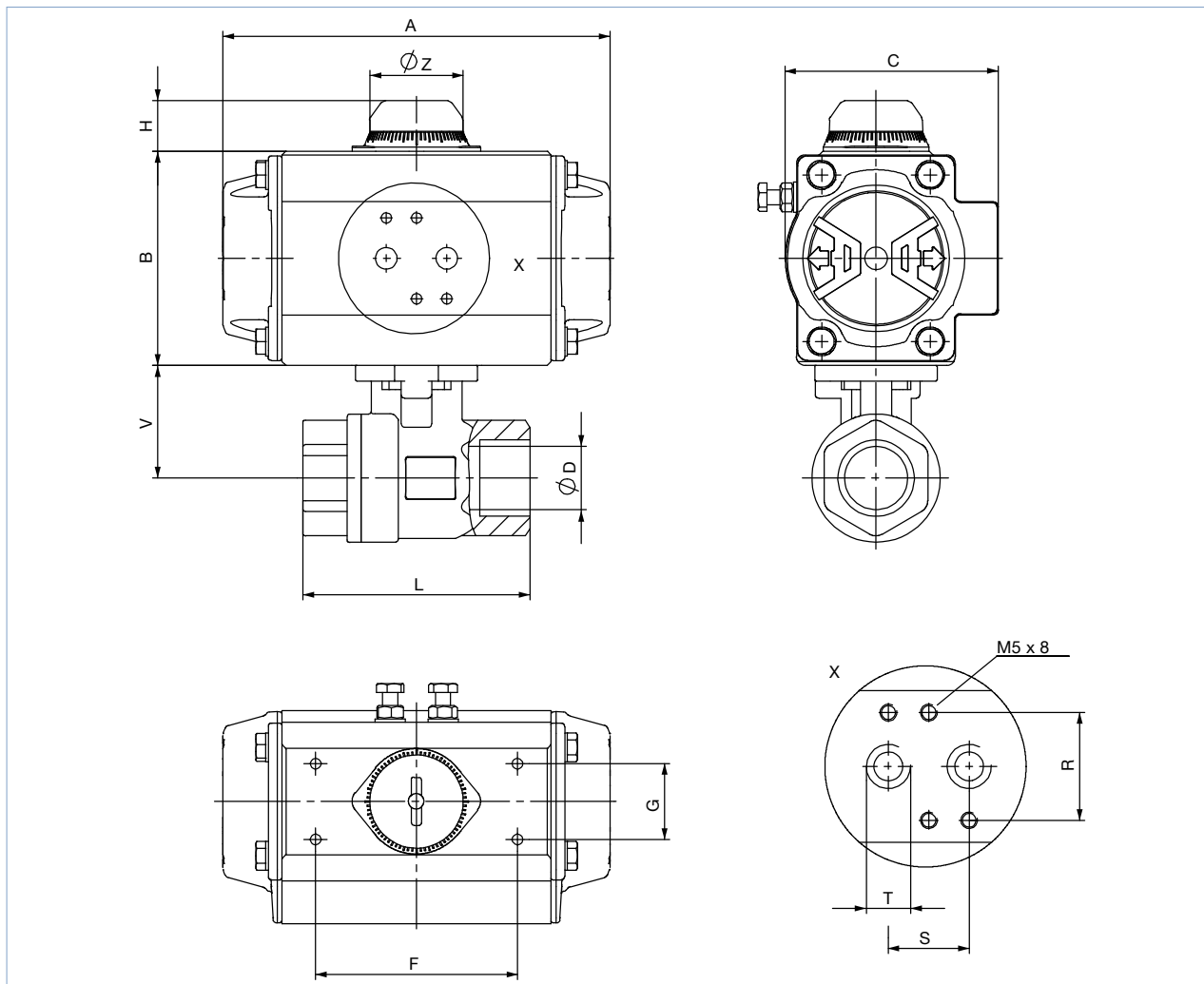

Orifice	Port connection	Actuator	Actuator dimensions										Valve dimensions		
			A	B	C	F	G	H	R	S	T	ØZ	L	ØD	V
[mm]	[inch]	[size]	[mm]	[mm]	[mm]	[mm]	[mm]	[mm]	[mm]	[mm]	[mm]	[inch]	[mm]	[mm]	[mm]
10	¼	15	136	69	72	80	30	20	32	24	⅙	37	50	11.6	33.2
12	⅜	15	136	69	72	80	30	20	32	24	⅙	37	60	12.7	33.2
15	½	15	136	69	72	80	30	20	32	24	⅙	37	75	15	35
		30	153.5	85	84.5	80	30	20	32	24	⅙	37			
20	¾	30	153.5	85	84.5	80	30	20	32	24	⅙	37	80	20	41
		60	203.5	102	93	80	30	20	32	24	⅙	37			
25	1	30	153.5	85	84.5	80	30	20	32	24	⅙	37	90	25	44.5
		60	203.5	102	93	80	30	20	32	24	⅙	37			
		100	241	115	106	80	30	20	32	24	⅙	37			
32	1¼	60	203.5	102	93	80	30	20	32	24	⅙	37	110	31.8	49.5
		100	241	115	106	80	30	20	32	24	⅙	37			
40	1½	100	241	115	106	80	30	20	32	24	⅙	37	120	38	55
		150	259	127	118.5	80	30	20	32	24	¼	37			
50	2	100	241	115	106	80	30	20	32	24	⅙	37	140	50.8	66.5
		220	304	145	136	80	30	20	32	24	¼	37			

DTS 1000109493 EN Version: O Status: RL (released | freigegeben | valide) printed: 05.01.2021

4.2. 2/2 way ball valve, compact flange ball valve

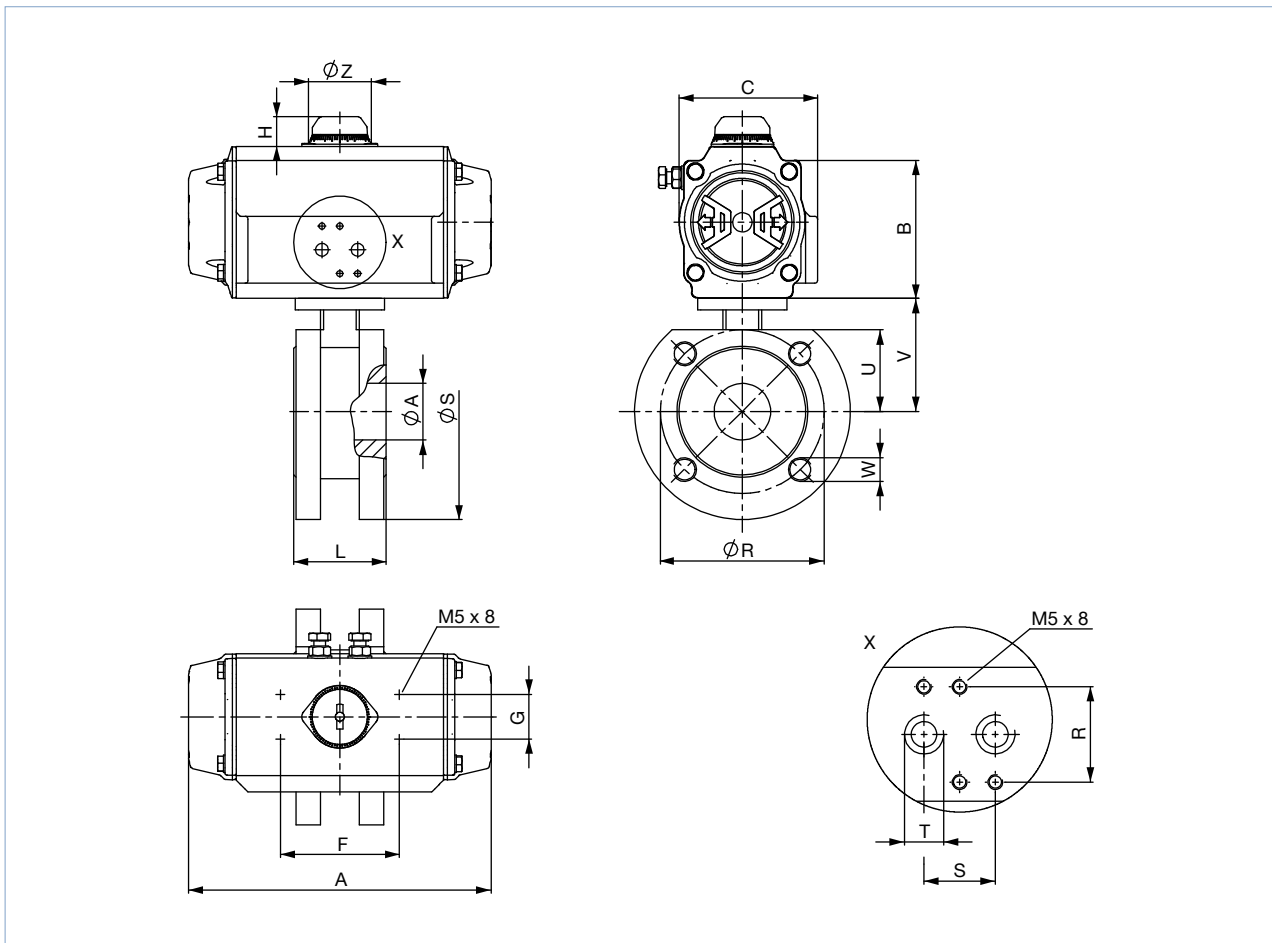

Orifice	Actuator	Actuator dimensions										Valve dimensions						Flange pattern
		A	B	C	F	G	H	R	S	T	ØZ	L	ØR	ØS	ØA	U	V	
[mm]	[size]	[mm]	[mm]	[mm]	[mm]	[mm]	[mm]	[mm]	[mm]	[mm]	[inch]	[mm]	[mm]	[mm]	[mm]	[mm]	[mm]	[mm]
20	15	140.5	69	59	80	30	20	32	24	1/8	42	44	75	105	20	38.5	64.3	M12 x 1.75
	30	158.5	85	72	80	30	20	32	24	1/8	42							
25	30	158.5	85	72	80	30	20	32	24	1/8	42	53	85	115	25	44.6	64.6	M12 x 1.75
	60	210.5	102	84.5	80	30	20	32	24	1/8	42							
32	30	158.5	85	72	80	30	20	32	24	1/8	42	58.4	100	135	32	51	69.0	M16 x 2
	60	210.5	102	84.5	80	30	20	32	24	1/8	42							
40	60	210.5	102	84.5	80	30	20	32	24	1/8	42	62	110	145	38	55	76.3	M16 x 2
	100	247.5	115	97.5	80	30	20	32	24	1/8	42							
50	60	210.5	102	84.5	80	30	20	32	24	1/8	42	78	125	155	50	63	85.7	M16 x 2
	150	268.5	127	111	80	30	20	32	24	1/4	42							
65	100	247.5	115	97.5	80	30	20	32	24	1/8	42	100	145	185	65	73.5	105	M16 x 2 (8 bores)
	220	315	145	127	80	30	30	32	24	1/4	58							
80	100	247.5	115	97.5	80	30	20	32	24	1/8	42	120	160	200	76	94	123	M16 x 2 (8 bores)
	300	345	157	136	80	30	30	32	24	1/4	42							
100	150	268.5	127	111	80	30	20	32	24	1/4	42	152	180	220	96	105	132	M16 x 2 (8 bores)
	300	345	157	136	80	30	30	32	24	1/4	58							

DTS 1000109493 EN Version: O Status: RL (released | freigegeben | valide) printed: 05.01.2021

4.3. 2/2 way ball valve, stainless steel body, 3 pieces, threaded connection

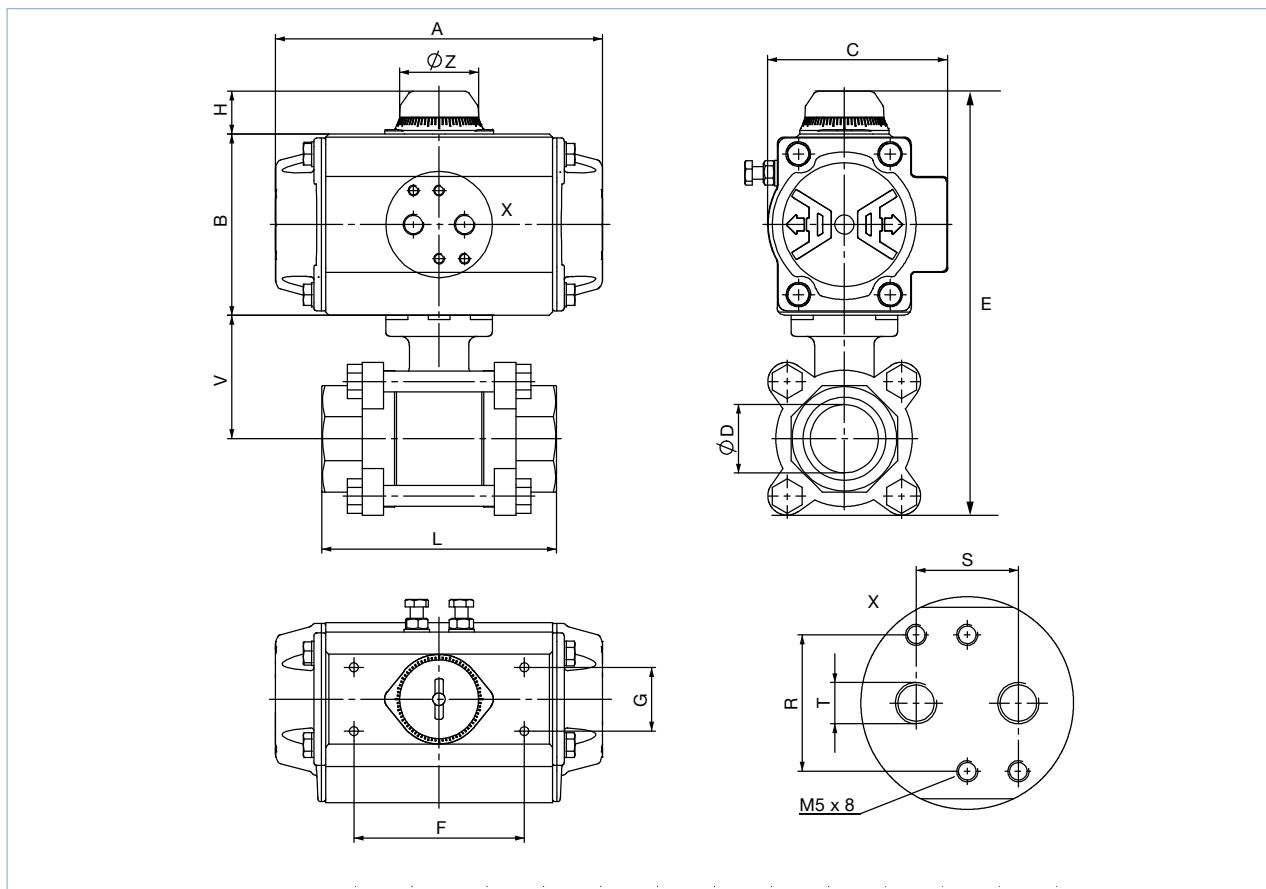

Orifice	Port connection	Actuator	Actuator dimensions										Valve dimensions			
			A	B	C	E	F	G	H	R	S	T	ØZ	L	ØD	V
[mm]	[inch]	[size]	[mm]	[mm]	[mm]	[mm]	[mm]	[mm]	[mm]	[mm]	[mm]	[inch]	[mm]	[mm]	[mm]	[mm]
10	¼	15	136	69	72	155	80	30	20	32	24	⅜	37	65	10	40
12	⅜	15	136	69	72	155	80	30	20	32	24	⅜	37	65	12	40
15	½	15	136	69	72	171	80	30	20	32	24	⅜	37	75	15	40
		30	153.5	85	84.5	80	30	20	32	24	⅜	37				
20	¾	15	136	69	72	177	80	30	20	32	24	⅜	37	80	20	44
		30	153.5	85	84.5	80	30	20	32	24	⅜	37				
25	1	15	136	69	72	206	80	30	20	32	24	⅜	37	90	25	52
		60	203.5	102	93	80	30	20	32	24	⅜	37				
32	1¼	30	153.5	85	84.5	217.5	80	30	20	32	24	⅜	37	110	32	58
		60	203.5	102	93	80	30	20	32	24	⅜	37				
40	1½	30	153.5	85	84.5	245	80	30	20	32	24	⅜	37	120	40	68
		100	241	115	106	80	30	20	32	24	⅜	37				
50	2	60	203.5	102	93	262.5	80	30	20	32	24	⅜	37	140	50	77
		100	241	115	106	80	30	20	32	24	⅜	37				
65	2½	100	241	115	106	309	80	30	20	32	24	⅜	37	185	65	98
		150	259	127	118.5	80	30	20	32	24	¼	37				
80	3	150	259	127	118.5	370.5	80	30	20	32	24	¼	37	205	80	110
		220	304	145	136	80	30	30	32	24	¼	51				
100	4	150	259	127	118.5	422	80	30	20	32	24	¼	37	240	100	138
		300	333	157	146.5	80	30	30	32	24	¼	51				

DTS 1000109493 EN Version: O Status: RL (released | freigegeben | valide) printed: 05.01.2021

4.4. 2/2 way ball valve, stainless steel body, 3 pieces, welded connection

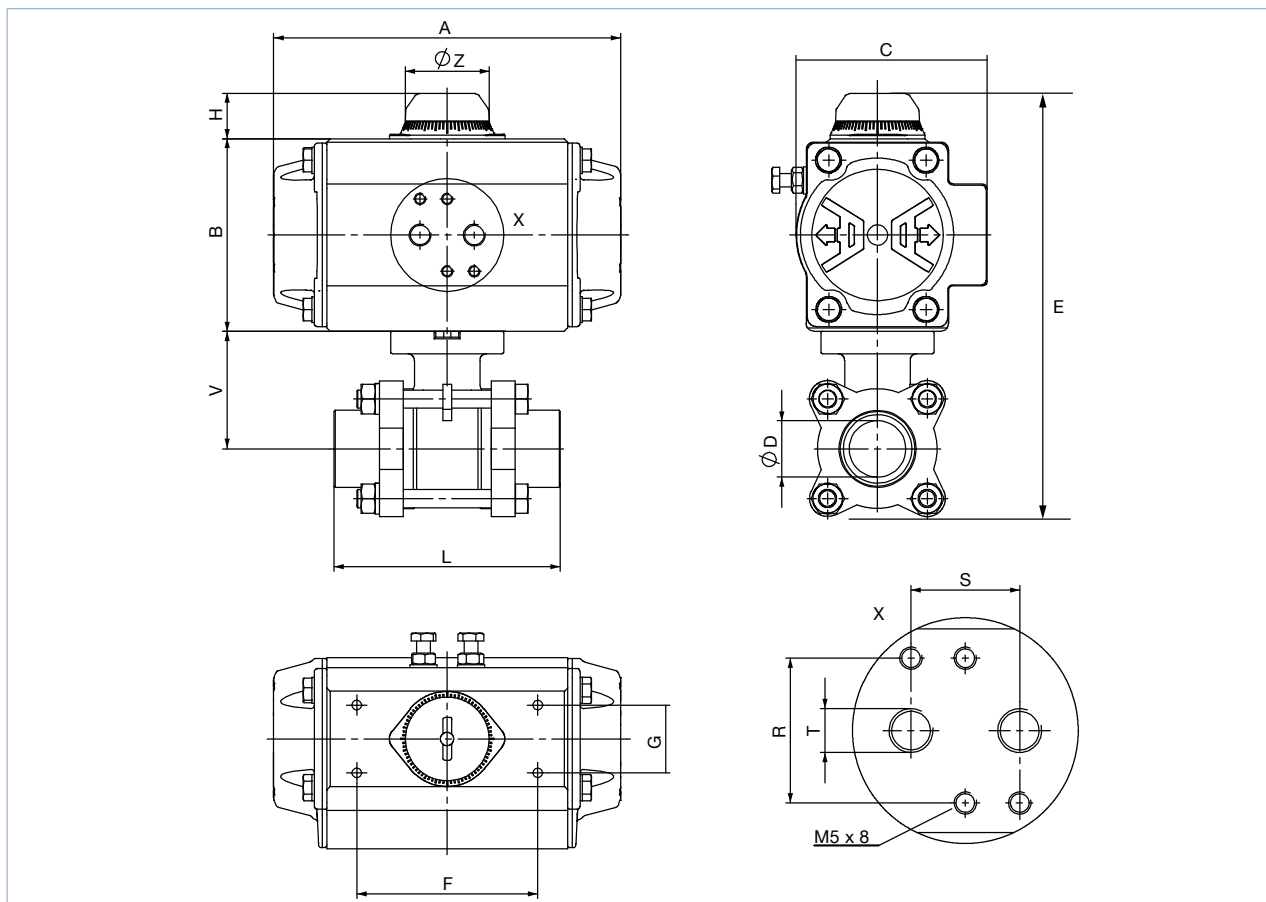

Orifice	Port connection	Actuator	Actuator dimensions											Valve dimensions		
			A	B	C	E	F	G	H	R	S	T	ØZ	L	ØD	V
[mm]	[inch]	[size]	[mm]	[mm]	[mm]	[mm]	[mm]	[mm]	[mm]	[mm]	[mm]	[mm]	[inch]	[mm]	[mm]	[mm]
12	3/8	15	136	69	72	155	80	30	20	32	24	1/8	37	70	12	40
15	1/2	15	136	69	72	171	80	30	20	32	24	1/8	37	75	15	40
		30	153.5	85	84.5		80	30	20	32	24	1/8	37			
20	3/4	15	136	69	72	177	80	30	20	32	24	1/8	37	90	20	44
		30	153.5	85	84.5		80	30	20	32	24	1/8	37			
25	1	15	136	69	72	206	80	30	20	32	24	1/8	37	100	25	52
		60	203.5	102	93		80	30	20	32	24	1/8	37			
32	1 1/4	30	153.5	85	84.5	217.5	80	30	20	32	24	1/8	37	110	32	58
		60	203.5	102	93		80	30	20	32	24	1/8	37			
40	1 1/2	30	153.5	85	84.5	245	80	30	20	32	24	1/8	37	125	40	68
		100	241	115	106		80	30	20	32	24	1/8	37			
50	2	60	203.5	102	93	262.5	80	30	20	32	24	1/8	37	150	50	77
		100	241	115	106		80	30	20	32	24	1/8	37			
65	2 1/2	100	241	115	106	309	80	30	20	32	24	1/8	37	190	65	98
		150	259	127	118.5		80	30	20	32	24	1/4	37			
80	3	150	259	127	118.5	370.5	80	30	20	32	24	1/4	37	220	80	110
		220	304	145	136		80	30	30	32	24	1/4	51			
100	4	150	259	127	118.5	422	80	30	20	32	24	1/4	37	270	100	138
		300	333	157	146.5		80	30	30	32	24	1/4	51			

DTS 1000109493 EN Version: O Status: RL (released | freigegeben | valide) printed: 05.01.2021

4.5. 3/2 way ball valve, stainless steel body

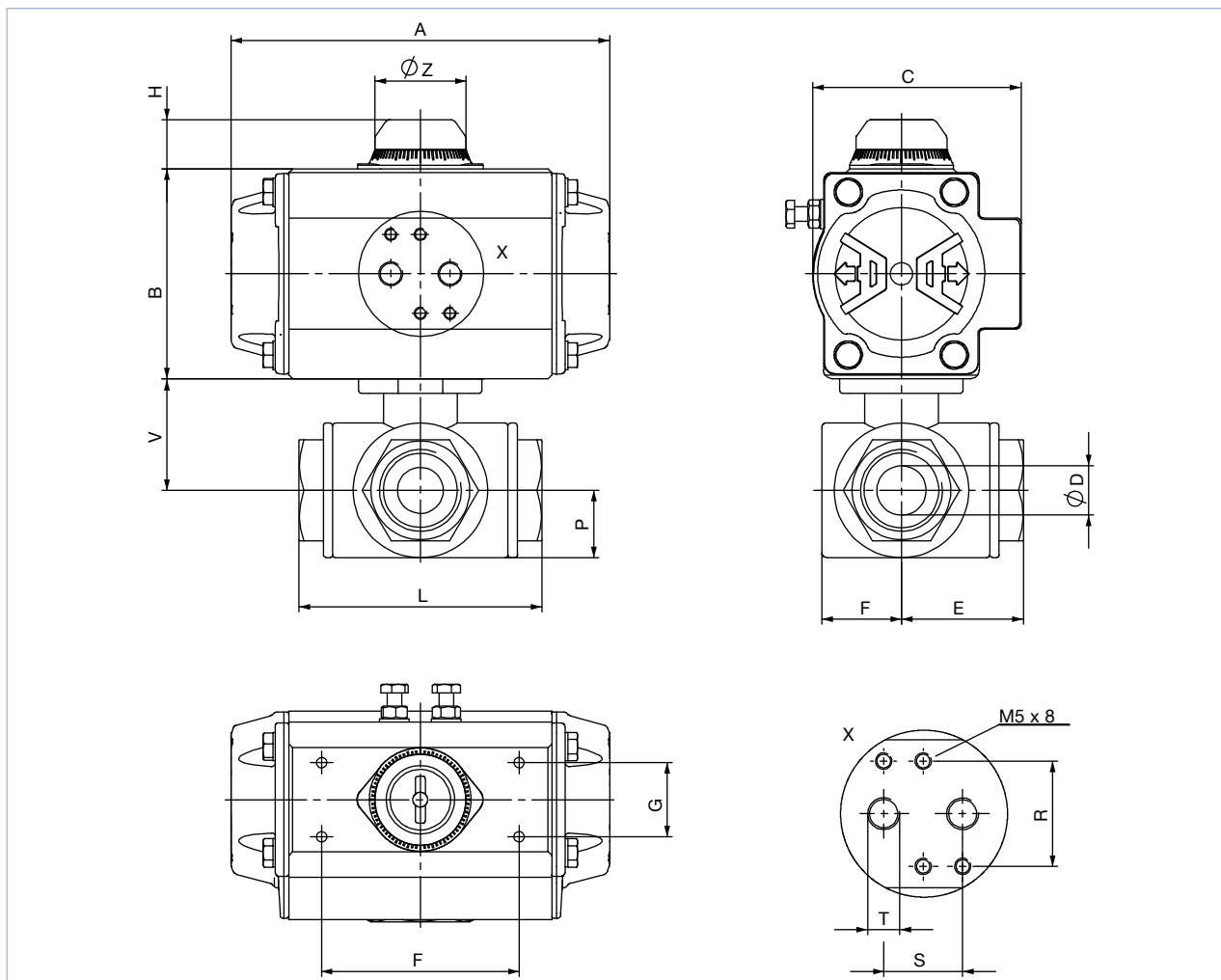

Orifice	Port connection	Actuator	Actuator dimensions										Valve dimensions						
			A	B	C	F	G	H	R	S	T	ØZ	L	ØD	E	F	P	V	
[mm]	[inch]	[size]	[mm]	[mm]	[mm]	[mm]	[mm]	[mm]	[mm]	[mm]	[mm]	[inch]	[mm]	[mm]	[mm]	[mm]	[mm]	[mm]	[mm]
12	¼	15	136	69	72	80	30	30	32	24	¼	37	80	12	39.9	22	19.8	35.9	
		30	153.5	85	84.5	80	30	20	32	24	¼	37							
12	⅜	15	136	69	72	80	30	20	32	24	⅜	37	80	12	39.9	22	19.8	35.9	
		30	153.5	85	84.5	80	30	20	32	24	⅜	37							
12	½	15	136	69	72	80	30	20	32	24	½	37	80	12	39.9	22	19.8	35.9	
		30	153.5	85	84.5	80	30	20	32	24	½	37							
15	¾	15	136	69	72	80	30	20	32	24	¾	37	87.5	15	43.7	23	32.2	42.1	
		60	203.5	102	93	80	30	20	32	24	¾	37							
20	1	30	153.5	85	84.5	80	30	20	32	24	1	37	100	20	46.5	32.4	27.2	46.5	
		60	203.5	102	93	80	30	20	32	24	1	37							
25	1¼	60	203.5	102	93	80	30	20	32	24	1¼	37	123	25	52.1	38.3	34.2	52.1	
		100	241	115	106	80	30	20	32	24	1¼	37							
32	1½	60	203.5	102	93	80	30	20	32	24	1½	37	142.2	32	57.4	43	38.3	57.4	
		100	241	115	106	80	30	20	32	24	1½	37							
40	2	100	241	115	106	80	30	20	32	24	2	37	170.6	40	66	56.2	49	66	
		150	259	127	118.5	80	30	20	32	24	2	37							

DTS 1000109493 EN Version: O Status: RL (released | freigegeben | valide) printed: 05.01.2021

5. Performance specifications

5.1. Pressure temperature diagram

Pressure temperature chart for stainless steel

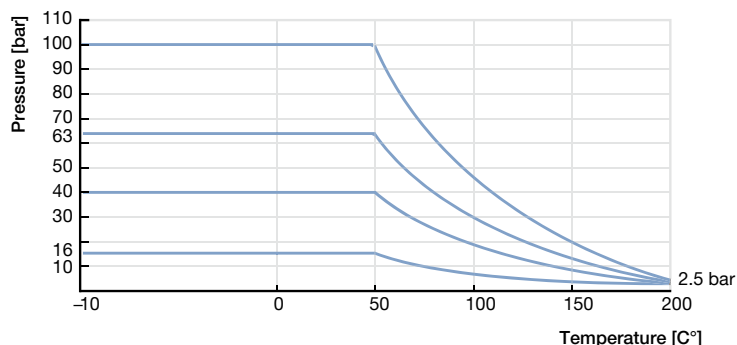

5.2. Switching position of the 3/2 way ball valves

Ball configuration	T			L
Position				
0°				
90°				
Switching position	T1	T2	T3	L4

6. Ordering information

6.1. Bürkert eShop – Easy ordering and quick delivery



Bürkert eShop – Easy ordering and fast delivery

You want to find your desired Bürkert product or spare part quickly and order directly? Our online shop is available for you 24/7. Sign up and enjoy all the benefits.

[Order online now](#)

6.2. Bürkert product filter



Bürkert product filter – Get quickly to the right product

You want to select products comfortably based on your technical requirements? Use the Bürkert product filter and find suitable articles for your application quickly and easily.

[Try out our product filter](#)

6.3. Ordering chart 2/2 way ball valve

Note:

Stainless steel (minimum control pressure 6 bar)

Control function	Orifice DN [mm]	Port connection [inch]	K _v value water		Nominal pressure ^{1.)}		Actuator		Article no.		
			StSt. 2 pieces [m³/h]	StSt. 3 pieces [m³/h]	StSt. 2 pieces [bar]	StSt. 3 pieces [bar]	StSt. 2 pieces [size]	StSt. 3 pieces [size]	StSt. 3 pieces weld end port connection	StSt. 2 pieces threaded port connection	StSt. 3 pieces threaded port connection
A	10	¼	9	9	100	63	15	15	-	217232	217250
	12	⅜	13	13	100	63	15	15	217261	217233	217251
	15	½	19	19	100	63	30	30	217262	217234	217252
	20	¾	46	46	100	63	60	30	217263	217235	217253
	25	1	72	72	100	63	60	60	217264	217236	217254
	32	1¼	105	105	100	63	100	60	217265	217237	217255
	40	1½	170	170	100	63	150	100	217266	217238	217256
	50	2	275	275	100	63	220	100	217267	217239	217257
	65	2½	-	507	-	63	-	150	217268	-	217258
	80	3	-	905	-	63	-	220	217269	-	217259
100	4	-	1414	-	63	-	300	217270	-	217260	
B	10	¼	-	9	-	63	-	15	On request	On request	217292
	12	⅜	9	9	-	63	-	15	On request	On request	217293
	15	½	19	19	-	63	-	30	On request	On request	217294
	20	¾	46	46	-	63	-	30	On request	On request	217295
	25	1	72	72	-	63	-	60	On request	On request	217296
	32	1¼	105	105	-	63	-	60	On request	On request	217297
	40	1½	170	170	-	63	-	100	On request	On request	217298
	50	2	275	275	-	63	-	100	On request	On request	217299
	65	2½	-	507	-	63	-	150	On request	-	217300
	80	3	-	905	-	63	-	220	On request	-	217301
100	4	-	1414	-	63	-	300	On request	-	217302	
I	10	¼	9	9	100	63	15	15	-	217240	217271
	12	⅜	9	9	100	63	15	15	217282	217241	217272
	15	½	19	19	100	63	15	15	217283	217242	217273
	20	¾	46	46	100	63	30	15	217284	217243	217274
	25	1	72	72	100	63	30	15	217285	217244	217275
	32	1¼	105	105	100	63	60	30	217286	217245	217276
	40	1½	170	170	100	63	100	30	217287	217246	217277
	50	2	275	275	100	63	100	60	217288	217247	217278
	65	2½	-	507	-	63	-	100	217289	-	217279
	80	3	-	905	-	63	-	150	217290	-	217280
100	4	-	1414	-	63	-	150	217291	-	217281	

1.) Operating pressure see "5.1. Pressure temperature diagram" on page 11.

Further versions on request



Additional

- Ball valves brass, nickel-plated
- Further connections and orifices
- Non standard fittings and versions

6.4. Ordering chart 2/2 way compact flange ball valve

Note:

Switching position 0°/90°

Control function	Orifice	K _v value water	Nominal pressure ^{1.)}	Actuator	Weight	Article no.
	[mm]	[m ³ /h]	[bar]	[size]	[kg]	
A	20	46	40	30	3.8	217306
	25	72	40	60	6.0	217307
	32	105	40	60	7.7	217308
	40	170	40	100	9.8	217309
	50	275	40	150	12.8	217310
	65	507	16	220	20	217311
	80	905	16	300	26.3	217312
	100	1414	16	300	29.0	217313
I	20	46	40	15	2.1	217314
	25	72	40	30	4.4	217315
	32	105	40	30	6.2	217316
	40	170	40	60	8.1	217317
	50	275	40	60	9.0	217318
	65	507	16	100	14.0	217319
	80	905	16	100	17.3	217320
	100	1414	16	150	21.8	217321



















1.) Operating pressure see "5.1. Pressure temperature diagram" on page 11

6.5. Ordering chart 3/2 way ball valve

Note:

- Reduced nominal diameter/orifice, minimum control pressure 6 bar, T2 and T3 on request
- Switching position 0°/90°

Switching position	Orifice	Port connection	K _v value water	Nominal pressure ^{1.)}	Actuator single acting	Article no. single acting	Actuator double acting	Article no. double acting
	[mm]	[inch]	[m ³ /h]	[bar]	SFA	SFA	SFI	SFI
T1 0° 	10	¼	4.7 / 6.9 ^{2.)}	63	30	217342	15	217352
	12	⅜	4.7 / 6.9 ^{*2.)}	63	30	217343	15	217353
	12	½	6.9 / 11.2 ^{2.)}	63	30	217344	15	217354
	15	¾	6.9 / 11.2 ^{2.)}	63	60	217345	15	217355
	20	1	18.9 / 29.2 ^{2.)}	63	60	217346	30	217356
90° 	25	1¼	35.3 / 46.4 ^{2.)}	63	100	217347	60	217357
	32	1½	46.4 / 72.2 ^{2.)}	63	100	217348	60	217358
	40	2	83.4 / 135.6 ^{2.)}	63	150	217349	100	217359

Switching position	Orifice	Port connection	K _v value water	Nominal pressure ^{1.)}	Actuator single acting	Article no. single acting	Actuator double acting	Article no. double acting
	[mm]	[inch]	[m ³ /h]	[bar]	SFA	SFA	SFI	SFI
L4 0° 	10	¼	5.6	63	30	217325 	15	217333 
	12	⅜	5.6	63	30	217326 	15	217334 
	12	½	9.5	63	30	217327 	15	217335 
	15	¾	9.5	63	60	217328 	15	217336 
	20	1	25.8	63	60	217329 	30	217337 
90° 	25	1¼	40.4	63	100	217330 	60	217338 
	32	1½	60.2	63	100	217331 	60	217339 
	40	2	114.4	63	150	217332 	100	217340 

1.) Operating pressure see "5.1. Pressure temperature diagram" on page 11.









2.) Switching position 0°/90°

6.6. Ordering chart accessories

Position feedback Type 1061

Note:

- Adjustable mounting bracket included
- Further versions see data sheet **Type 1061** ▶.

Description	Article no.
Position feedback (electromechanical)	773151 
Position feedback (electromechanical) with integrated 3/2 way solenoid valve	773139 
Position feedback (electromechanical) with integrated 5/2 way solenoid valve	773140 
Position feedback (inductive)	773152 
Position feedback (inductive) with integrated 3/2 way solenoid valve	773141 
Position feedback (inductive) with integrated 5/2 way solenoid valve	773142 
Position feedback (inductive) – ATEX version	773153 
Position feedback (inductive) with integrated 3/2 way solenoid valve – ATEX version	773143 
Position feedback (inductive) with integrated 5/2 way solenoid valve – ATEX version	773144 

Positioner Type 8792

Note:

Further versions see data sheet **Type 8792** ▶.

Description	Article no.
Positioner SideControl without analogue feedback	317985 
Positioner SideControl with analogue feedback	317986 

Positioner mounting kit Type 8792/3

Note:

Further versions see data sheet **Type 8792** ▶ or **Type 8793** ▶.

Description	Article no.
Universal adapter for shaft	787338 
Universal mounting bracket	770294 

Type 6519 Namur

Note:

- Only recommended up to actuator size 220
- For further information see data sheet **Type 6519 Namur** ▶

Control function	Orifice	Seal material body	Thread insert material ^{1.)}	Port connection threaded port	Q _{Nn} value air ^{2.)}	Pressure range ^{3.)}	Weight	Nominal power	Voltage/Frequency	Article no.
	[mm]								[V/Hz]	
C 3/2 way Solenoid valve servo-operated, normally closed, with manual override	6.0	NBR and PUR	Stainless steel	G ¼	900	2...8	460	2	24/DC	131425
									24/50...60	131426
									110/50...60	131427
									230/50...60	131428
H 5/2 way Solenoid valve servo-operated, with manual override	6.0	NBR and PUR	Brass, nickel-plated	G ¼	900	2...8	460	2	24/DC	131421
									24/50...60	131422
									110/50...60	131423
									230/50...60	131424

Cable plug Type 2516 according to DIN EN 175301 - 803 Form C

Note:

- A flat seal and a fixing screw are included in the scope of delivery of the cable plug.
- For further versions on wired cable plugs to DIN EN 175301 - 803 Form C and detailed technical data, see data sheet **Type 2516** ▶.

Cable plug	Version	Voltage	Article no.
	Without circuitry (Standard)	0...250 V AC/DC	303141
	With LED	12...24 V AC/DC	303145
	With LED and varistor	12...24 V AC/DC	303148
	With rectifier, LED and varistor	12...24 V AC/DC	303142







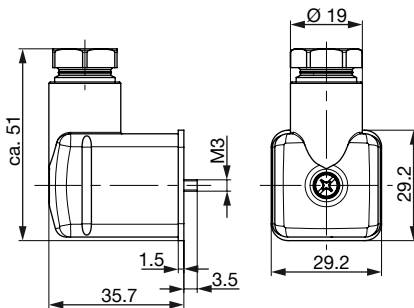



Cable plug Type 2518, Form A according to DIN EN 175301 -803

Note:

Further versions see data sheet [Type 2518](#) ▶.

Cable plug	Dimensions	Version	Voltage	Article no.
		Without circuitry (AC/DC)	0...250 V AC/DC	314802
		With LED (AC/DC)	12...24 V AC/DC	314812
		With LED and varistor (AC/DC)	12...24 V AC/DC	314820
		With rectifier, LED and varistor	12...24 V AC/DC	314816

Conversion sleeves

Description	Article no.
Conversion Sleeve star/square 14/9 mm	665288 
Conversion Sleeve star/square 14/11 mm	665289 
Conversion Sleeve square/square 17/14 mm	665290 
Conversion Sleeve star/square 17/14 mm	773348 
Conversion Sleeve star/square 17/11 mm	773343 
Conversion Sleeve square/square 22/19 mm	773836 
Conversion Sleeve star/square 22/17 mm	684858 
Conversion Sleeve star/star 22/14 mm	666684 
Conversion Sleeve star/square 22/11 mm	773344 
Conversion Sleeve star/square 27/22 mm	774594 
Conversion Sleeve square/square 27/19 mm	774279 
Conversion Sleeve square/square 27/17 mm	774193 