

**По вопросам продаж и поддержки обращайтесь:**

Архангельск (8182)63-90-72	Краснодар (861)203-40-90	Рязань (4912)46-61-64
Астана (7172)727-132	Красноярск (391)204-63-61	Самара (846)206-03-16
Белгород (4722)40-23-64	Курск (4712)77-13-04	Санкт-Петербург (812)309-46-40
Брянск (4832)59-03-52	Липецк (4742)52-20-81	Саратов (845)249-38-78
Владивосток (423)249-28-31	Магнитогорск (3519)55-03-13	Смоленск (4812)29-41-54
Волгоград (844)278-03-48	Москва (495)268-04-70	Сочи (862)225-72-31
Вологда (8172)26-41-59	Мурманск (8152)59-64-93	Ставрополь (8652)20-65-13
Воронеж (473)204-51-73	Набережные Челны (8552)20-53-41	Тверь (4822)63-31-35
Екатеринбург (343)384-55-89	Нижний Новгород (831)429-08-12	Томск (3822)98-41-53
Иваново (4932)77-34-06	Новокузнецк (3843)20-46-81	Тула (4872)74-02-29
Ижевск (3412)26-03-58	Новосибирск (383)227-86-73	Тюмень (3452)66-21-18
Казань (843)206-01-48	Орел (4862)44-53-42	Ульяновск (8422)24-23-59
Калининград (4012)72-03-81	Оренбург (3532)37-68-04	Уфа (347)229-48-12
Калуга (4842)92-23-67	Пенза (8412)22-31-16	Челябинск (351)202-03-61
Кемерово (3842)65-04-62	Пермь (342)205-81-47	Череповец (8202)49-02-64
Киров (8332)68-02-04	Ростов-на-Дону (863)308-18-15	Ярославль (4852)69-52-93

**Единый адрес:** [btk@nt-rt.ru](mailto:btk@nt-rt.ru)    **Веб-сайт:** [www.burkert.nt-rt.ru](http://www.burkert.nt-rt.ru)

## **ДАТЧИКИ И РЕЛЕ ДАВЛЕНИЯ**

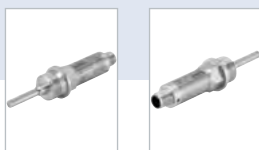

## RTD Temperature sensor with IO-Link interface

- Single RTD temperature probe, type Pt1000
- Process connections: G ½", clamp DN 10/20 according to DIN 32676
- Temperature measurement range: -50...+150 °C
- Switching functions available : PNP or NPN
- Access to measurement value, device status and settings via IO-Link interface, very easy sensor replacement

Product variants described in the data sheet may differ from the product presentation and description.

### Type description

The temperature sensor is used for temperature measurement and monitoring. The effect of the temperature on a resistance RTD temperature probe generates a signal, which is amplified, digitalized and processed.

Instead of an analogue output this device offers a digital interface IO-Link. This allows bidirectional data transfer with any IO-Link Master. Data access is done by using the available standardized IO-Link.

The IO-Link is in accordance to the specification version 1.1. IO-Link. The bidirectional communication is used to read process data, diagnostic information, status messages and to set parameters. The two green LEDs are permanently lit as soon as power is supplied to the device. Once an IO-Link connection is established, the LEDs flash.

The switching behaviour and the switching thresholds of the digital outputs (max. 2 pieces; "PNP" or "NPN") can be individually configured – as well as many other parameters.

## 1. General Technical Data

Product properties	
<b>Material</b>	
<b>Non wetted parts</b>	
Housing	Stainless steel 1.4571 (316Ti)
<b>Wetted parts</b>	
Process connection	<ul style="list-style-type: none"> <li>Stainless steel 1.4404 (316L) for thread connection version</li> <li>Stainless steel 1.4435 (316L) for clamp connection version (with low delta ferrite content)</li> </ul>
Protection tube	<ul style="list-style-type: none"> <li>Stainless steel 1.4404 (316L) for thread connection version</li> <li>Stainless steel 1.4435 (316L) for clamp connection version</li> </ul>
Dimensions	Detailed information can be found in chapter <a href="#">“3. Dimensions” on page 6.</a>
Measurement element	RTD temperature probe Pt1000, four-wire circuit
Probe length	50 or 100 mm
Measuring range	-50...+150 °C (-58...+302 °F)
Monitoring	Measuring circuit: IO-Link event configurable and is available as device status <ul style="list-style-type: none"> <li>Process data invalid</li> <li>Measuring range overflow</li> <li>Measuring range underflow</li> <li>Device hardware fault</li> </ul>
Additional functions	<ul style="list-style-type: none"> <li>Fine adjustment</li> <li>Change between °C/°F</li> <li>Data format switchover (integer/floating point)</li> <li>Switching outputs in SIO mode</li> </ul>
Weight	Approx. 80 g for the version with thread connection and 100 mm probe length. The weight of the temperature sensor depends on the process connection and the insertion length.
Performance data	
Sampling rate	160 ms
Transmission behaviour	Temperature linear
Response time	Protection tube Ø6 mm (standard): <ul style="list-style-type: none"> <li><math>t_{0.5} = 5</math> s; <math>t_{0.9} = 12</math> s, in water with a flow velocity of 0.4 m/s</li> <li><math>t_{0.5} = 40</math> s; <math>t_{0.9} = 110</math> s, in air with a flow velocity of 3.0 m/s</li> </ul>
Measuring resolution	14 bit
Measurement deviation	<ul style="list-style-type: none"> <li>Tolerance class A, <math>\pm(0.15 + 0.002 \times  t ^{1.1})</math> °C according to EN 60751:2009/IEC 60751:2008</li> <li><math>\leq \pm(0.08 \%)^{2.1}</math> (calibration of the electronic components)</li> </ul>
Electrical data	
Operating voltage	<ul style="list-style-type: none"> <li>In IO-Link operation: 18...32 V DC, filtered and regulated</li> <li>In switch operation: 9.6...32 V DC, filtered and regulated</li> <li>Nominal voltage: 24 V DC</li> </ul>
Power source (not supplied)	The auxiliary energy of the pressure sensor must meet SELV requirements; optionally, an energy-limited current circuit according to section 9.3 of DIN EN 61010-1 and UL 61010-1 can be used
Current consumption	<ul style="list-style-type: none"> <li>In idle operation: <math>\leq 12</math> mA (at nominal voltage)</li> <li>In IO-Link operation: <math>\leq 20</math> mA (at nominal voltage)</li> <li>In switch operation: <math>\leq 200</math> mA (at nominal voltage and with 2 digital outputs)</li> </ul>
DC reverse polarity protection	Yes
Short circuit protection	Yes (clocked)
Current limiting	Yes
Switching current	$\leq 100$ mA per output
Measuring current	$\leq 500$ $\mu$ A
Voltage drop at switching transistor	$\leq 2$ V DC
Galvanic isolation	To the protection tube; no galvanic isolation between sensor and output

Signal processing	Input filter: <ul style="list-style-type: none"> <li>digital filter, second order</li> <li>filter time constant can be set</li> </ul>
<b>Output signal</b>	
Quantity	<ul style="list-style-type: none"> <li>1 digital output in IO-Link operation</li> <li>2 digital outputs for switch operation (SIO mode; SIO = standard IO)</li> </ul>
Switching functions configurable	<ul style="list-style-type: none"> <li>Hysteresis function (Hysteresis configurable) or window function (hysteresis fixed setting, symmetrical, <math>\pm 0.25\%</math> of the measuring range)</li> <li>NC or NO contact</li> <li>Digital output PNP or NPN</li> <li>Switch-on/switch-off delay (0...100 s)</li> </ul>
Cable	4-wire unshielded cable, max. 20 m
<b>Medium data</b>	
Fluid	Liquid and gaseous medium
Fluid pressure	<ul style="list-style-type: none"> <li>G 1/2" process connection: Max. 40 bar</li> <li>Clamp DN 10/20, according to DIN 3676. The permissible pressures are designed for an operating temperature range of -10 to +140 °C given use of suitable clamps and sealing materials.</li> </ul>
<b>Process/Port connection &amp; communication</b>	
Process connection	<ul style="list-style-type: none"> <li>G 1/2" according to EN 837</li> <li>Clamp DN 10/20 according to DIN 32676</li> </ul> Detailed information on the process connection can be found in chapter <b>"4.3. Ordering chart"</b> on page 7.
Electrical connection	M12 x 1 male connector, 4 pin (A-coded, non rotating)
<b>Digital communication: IO-Link</b>	
Communication interface	IO-Link device V1.1, downward compatible to V1.0
Baud rate (data transfer rate)	COM 3 (230.4 kBaud)
Cycle time	Min. 2 ms
IO device description (IODD)	Depending on the ordered input range See "Device Description Files" on the website in the Software chapter <b>Type 8418</b> ▶ available or at <a href="https://ioddfinder.io-link.com">https://ioddfinder.io-link.com</a>
<b>Approvals and certificates</b>	
<b>Standards</b>	
Degree of protection	IP66/IP67/IP69 according to IEC/EN 60529, with connector screwed on
Protection class	Class III according to EN 61140
<b>Directives</b>	
CE directives	The applied standards, which verify conformity with the EU Directives, can be found on the EU Type Examination Certificate and/or the EU Declaration of conformity (if applicable).
Electromagnetic compatibility (EMC)	CE conformity according to EN 61326-2-3 <ul style="list-style-type: none"> <li>Interference emission: class B</li> <li>Immunity to interference: to industrial requirements</li> </ul>
Pressure equipment directives	<ul style="list-style-type: none"> <li>The device does not meet the requirements for "safety accessories" within the meaning of the Pressure Equipment Directive 2014/68/EU.</li> <li>Complying with Article 4, Paragraph 1 of 2014/68/EU directive</li> </ul> Detailed information on the pressure equipment directive can be found in chapter <b>"2.1. Pressure Equipment Directive"</b> on page 5.
<b>Environment and installation</b>	
Ambient temperature	-40...+85 °C (-40...+185 °F) (operation <sup>4)</sup> and storage)
Temperature influence	$\leq \pm 0.0025\%$ per K <sup>2,3)</sup>
Relative air humidity	<ul style="list-style-type: none"> <li>During operation: <math>\leq 100\%</math>, without condensation on the outer housing surface of the device</li> <li>During storage: <math>\leq 90\%</math>, without condensation</li> </ul>
Climate class	3K7 according to EN 60721-3-3
Area of use	Indoors and outdoors (protect this device against electromagnetic interference, ultraviolet rays and the effects of climatic conditions)
Vibration resistance	According to EN 60068-2-6: 10 g with 10...500 Hz

Shock resistance	According to EN 60068-2-27: <ul style="list-style-type: none"> <li>• 20 g, 11 ms</li> <li>• 50 g, 1 ms</li> </ul>
Mounting position	Unrestricted

1.) |t| = temperature value in °C regardless of the prefix sign.

2.) All accuracy specifications in % relative to the respective measuring range

3.) Relative to the temperature deviation at the calibration point (25 °C ± 5 K)

4.) At process temperatures above 120 °C, the maximum admissible ambient temperature is 60 °C (stated at nominal voltage 24 V DC)

## 2. Approvals

### 2.1. Pressure Equipment Directive

The device conforms to Article 4, Paragraph 1 of the Pressure Equipment Directive 2014/68/EU under the following conditions:

#### Device used on a pipe

##### Note:

- The data in the table is independent of the chemical compatibility of the material and the fluid.
- PS = maximum admissible pressure, DN = nominal diameter of the pipe

Type of fluid	Conditions
Fluid group 1, Article 4, Paragraph 1.c.i	DN ≤ 25
Fluid group 2, Article 4, Paragraph 1.c.i	DN ≤ 32 or PS*DN ≤ 1000
Fluid group 1, Article 4, Paragraph 1.c.ii	DN ≤ 25 or PS*DN ≤ 2000
Fluid group 2, Article 4, Paragraph 1.c.ii	DN ≤ 200 or PS ≤ 10 or PS*DN ≤ 5000

#### Device used on a vessel

##### Note:

- The data in the table is independent of the chemical compatibility of the material and the fluid.
- PS = maximum admissible pressure, V = vessel volume

Type of fluid	Conditions
Fluid group 1, Article 4, Paragraph 1.a.i	V > 1 L and PS*V ≤ 25 bar.L or PS ≤ 200 bar
Fluid group 2, Article 4, Paragraph 1.a.i	V > 1 L and PS*V ≤ 50 bar.L or PS ≤ 1000 bar
Fluid group 1, Article 4, Paragraph 1.a.ii	V > 1 L and PS*V ≤ 200 bar.L or PS ≤ 500 bar
Fluid group 2, Article 4, Paragraph 1.a.ii	PS > 10 bar and PS*V ≤ 10000 bar.L or PS ≤ 1000 bar

### 3. Dimensions

**Note:**

Dimensions in mm

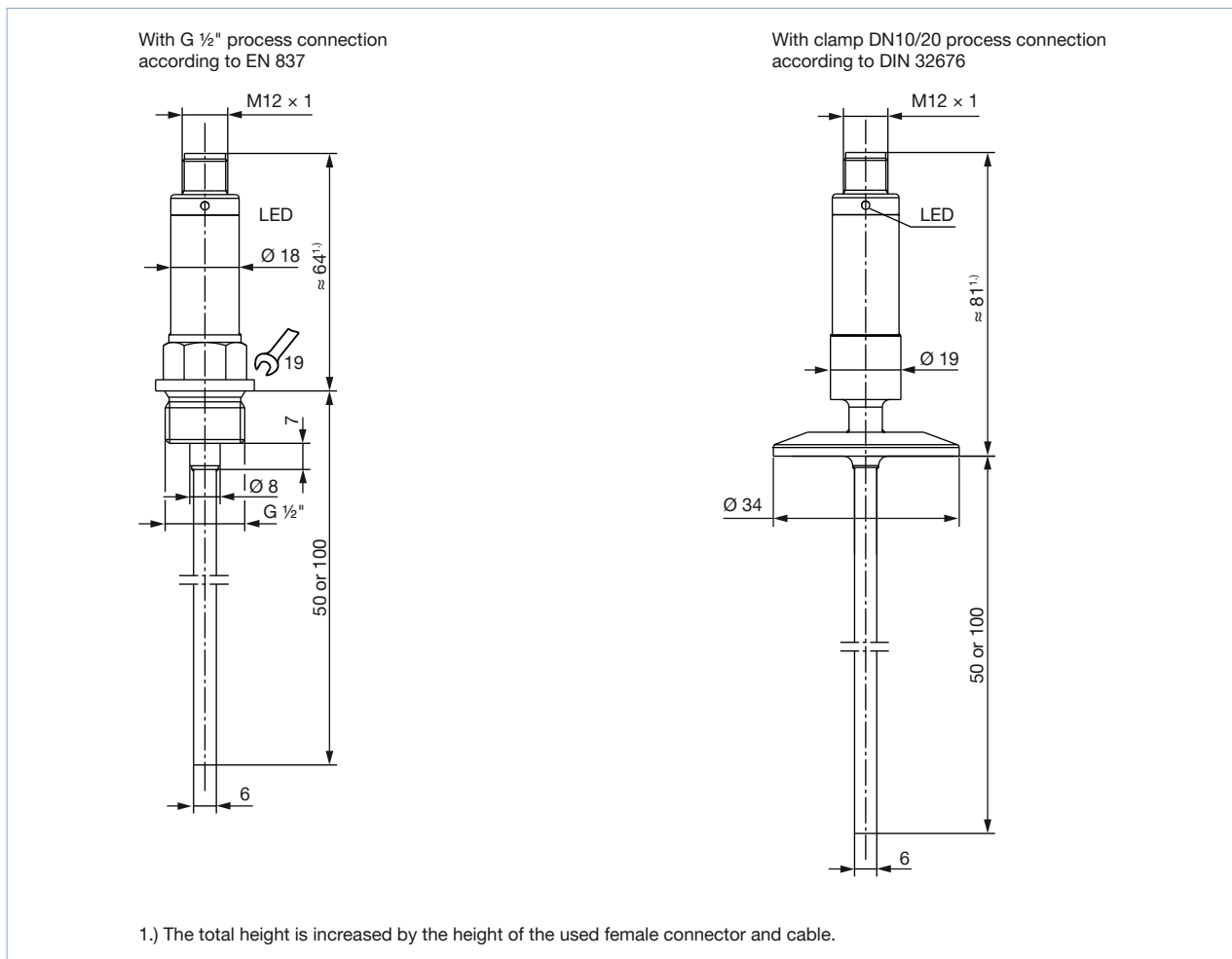

### 4. Ordering information

#### 4.1. Bürkert eShop – Easy ordering and quick delivery



**Bürkert eShop – Easy ordering and fast delivery**

You want to find your desired Bürkert product or spare part quickly and order directly? Our online shop is available for you 24/7. Sign up and enjoy all the benefits.

[Order online now](#)

## 4.2. Bürkert product filter



**Bürkert product filter – Get quickly to the right product**

You want to select products comfortably based on your technical requirements? Use the Bürkert product filter and find suitable articles for your application quickly and easily.

[Try out our product filter](#)





## 4.3. Ordering chart

### Note:

All following versions have

- an operating voltage depending on operation mode (IO-Link: 18...32 V DC, Switch: 9.6...32 V DC or Nominal: 24 V DC)
- an IO-Link digital interface (according to specification version 1.1) or digital outputs (SIO mode; SIO = standard IO)

Process connection	Temperature range	Probe length	Article no.
	[°C]	[mm]	
G ½" according to EN 837	-50...+150	50	574634 
		100	574635 
Clamp DN 10/20 according to DIN 32676		50	574636 
		100	574637 

Further versions on request	
 <p><b>Process connection</b></p> <ul style="list-style-type: none"> <li>• Screw-in thread G ¾"</li> <li>• Screw-in thread M12x1.5 and G ½" with CIP-compliant conical seal</li> <li>• Aseptic screw-in thread DN 20, DN 25, DN 32, DN 40, DN 50 according to DIN 11864-1 form A</li> <li>• Taper socket with union nut DN 10, DN 25, DN 32 according to DIN 11851 (dairy pipe fitting)</li> <li>• Clamping socket (clamp) DN 10/20, DN 25/40 according to DIN 32676</li> <li>• Clamping socket (clamp) DN 50 according to DIN 32676 (2" ISO 2852)</li> <li>• Clamping socket (clamp) 2 ½" similar to DIN 32676</li> <li>• Ball welding socket with threaded compression fitting</li> <li>• Welding socket with CIP-compliant conical seal</li> <li>• VARIVENT® connection DN 15/10, DN 32/25 or DN 50/40</li> <li>• BioControl® D25, D50, D65 or D80</li> </ul>	 <p><b>Temperature</b></p> <p>-50...+260 °C (-58...+500 °F)</p>  <p><b>Electrical connection</b></p> <p>IO-Link, M12x1 connector, high-temperature</p>  <p><b>Additional</b></p> <ul style="list-style-type: none"> <li>• Pt1000 temperature sensor, four-wire circuit</li> <li>• Class AA according to EN 60751:2009 / IEC 60751:2008</li> <li>• With protection tube diameter 3 mm only with screw-in thread M12 x 1.5 with CIP-compliant conical seal</li> <li>• Insertion length: 15, 20, 25 only with screw-in thread M12 x 1.5 with CIP-compliant conical seal or 150 mm</li> </ul>  <p><b>Certification</b></p> <ul style="list-style-type: none"> <li>• Inspection certificate 3.1 DIN EN 10204 (material)</li> <li>• Special calibration</li> </ul>

